

EUROFANS

OWNERS INSTRUCTION MANUAL

42"/106cm

Atom

**INSTALLATION
OPERATION
MAINTENANCE**

CAUTION

**READ INSTRUCTIONS CAREFULLY FOR SAFE
INSTALLATION AND FAN OPERATION. IF UNSURE CONSULT
A QUALIFIED ELECTRICIAN**

SUITABLE FOR 230V/50 CYCLE ELECTRICAL SUPPLY

Enquiries on installing your fan please call our help line on

01959-564440

technical@fantasiaceilingfans.com

IMPORTANT NOTES :

Please minimise risk of electrical shock by switching off electricity supply at the main circuit breaker. And read the following point carefully.

1. To ensure the success of the installation be sure to read the instructions and study the diagrams thoroughly before commencing.
2. All electrical work should only be undertaken after disconnection of the power by removing fuses or turning off the circuit breaker to ensure all pole isolation of the electrical supply. If you are in any doubt the services of a qualified electrician should be sought to ensure that all work is carried out in accordance with the I.E.E. Regulations, current good practice and other national and local electrical codes.
3. Make sure that your installation site will not allow the rotating fan blades to come into contact with any object and that there is a minimum clearance of 150mm (6") from the blade tip to the wall or ceiling. Please note that the bigger this clearance is the better the airflow from your fan will be. Ensure the blades are mounted at a minimum height of 2.3 meters (7'6") from the floor when the fan is installed.
4. The fixing point for the fan must be able to support a weight ten times that of the net weight of the fan. Net weights can be found on the bottom of the unit's box. If you are mounting the fan to a ceiling junction box, the box and it's fixing must be able to support the moving weight of the fan and must not twist or work loose.
5. The fan must be earthed.
6. Do not connect the fan motor to a dimmer switch. This may give an unsatisfactory performance (motor hum) and cause damage to the motor.
7. It is not recommended that ceiling fans and gas appliances are operated in the same room at the same time.
8. The fan must be turned off and stopped completely before reversing the fan direction. This will prevent any damage to the motor of the unit or controller (if installed).
9. Do not insert anything into the fan blades while the fan is operating. This will damage the blades and upset the balance of the unit causing the unit to wobble.
10. After the fan is completely installed make sure that all connections are secure and tight to prevent any problems.
11. Because of the fan's natural movement, some connections may loosen. Check the support connections, brackets and blade attachments twice a year to make sure they are all secure. If they are loose tighten with a screwdriver. (It is not necessary to take the fan down from the ceiling)

Note : The important safeguards and instructions given in this manual are not meant to cover all possible conditions and situations that may occur. It must be understood that common sense, caution and care are factors, which cannot be built into any product. These factors must be supplied by the persons caring for and using the unit.

For installation advice, or in the unlikely event of damaged or missing parts please ring:

HELP LINE : (01959) 564440

technical@fantasiaceilingfans.com

Installing the fan

All electrical work should only be undertaken after disconnection of the power by removing fuses or turning off the circuit breaker to ensure all pole isolation of the electrical supply.

Your fan can be installed in either of two options. It can be installed as a flush mount fan (Picture B), i.e. it is mounted as close to the ceiling as possible. It can also be installed as a drop rod style of fan (Picture A). In this situation the drop rod assembly is used to lower the fan down from its mounting position slightly. Extension rods, ranging from 12" to 72" (your fan is supplied with 6" Drop rod in the box), are available if you need to lower your fan further. (This is normally the case in conservatories or rooms with very high ceilings.)

Rods can be trimmed if necessary. If trimming is required cut excess from the bottom of the rod and re-drill a hole for the cotter pin.

Picture A
Drop Rod Style

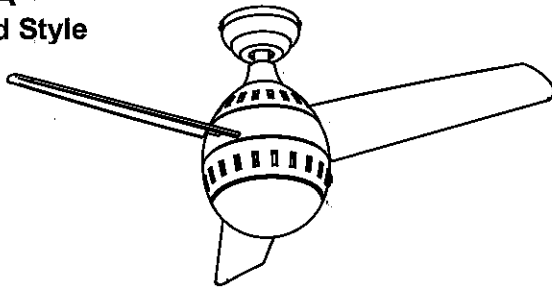

Picture B
Flush Mount Style

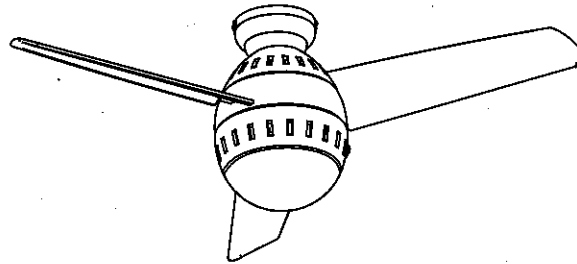

The following steps will guide you to a successful installation:

1. Hanging bracket installation
2. Down rod assembly style or flush mount assembly
3. Attaching the blades
4. Attaching bottom housing and light fitter
5. Remote Control and Wiring instructions
6. Installing shade

1. Hanger bracket installation

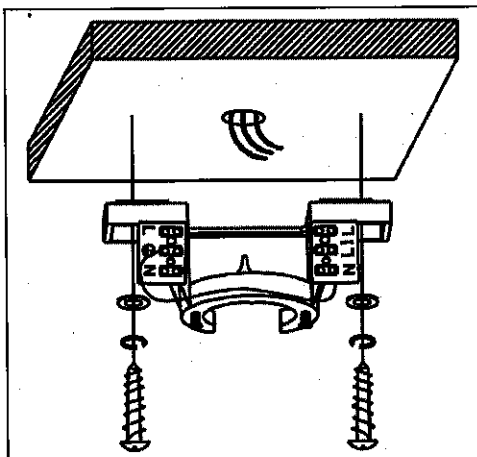

The hanging bracket should be screwed on to a firm flat surface. The fixing location must be able to withstand ten times the static weight of the fan. If you have any doubts as to the ability of your intended fixing location to be able to withstand this loading please contact our service help-line or another competent authority to advise you. In most situations two wood screws screwed in to a wooden joist is more than adequate to support your ceiling fan

The hanging bracket should be screwed onto the joist with the two wood screws provided. The washers provided should go in the following sequence:

PART LIST

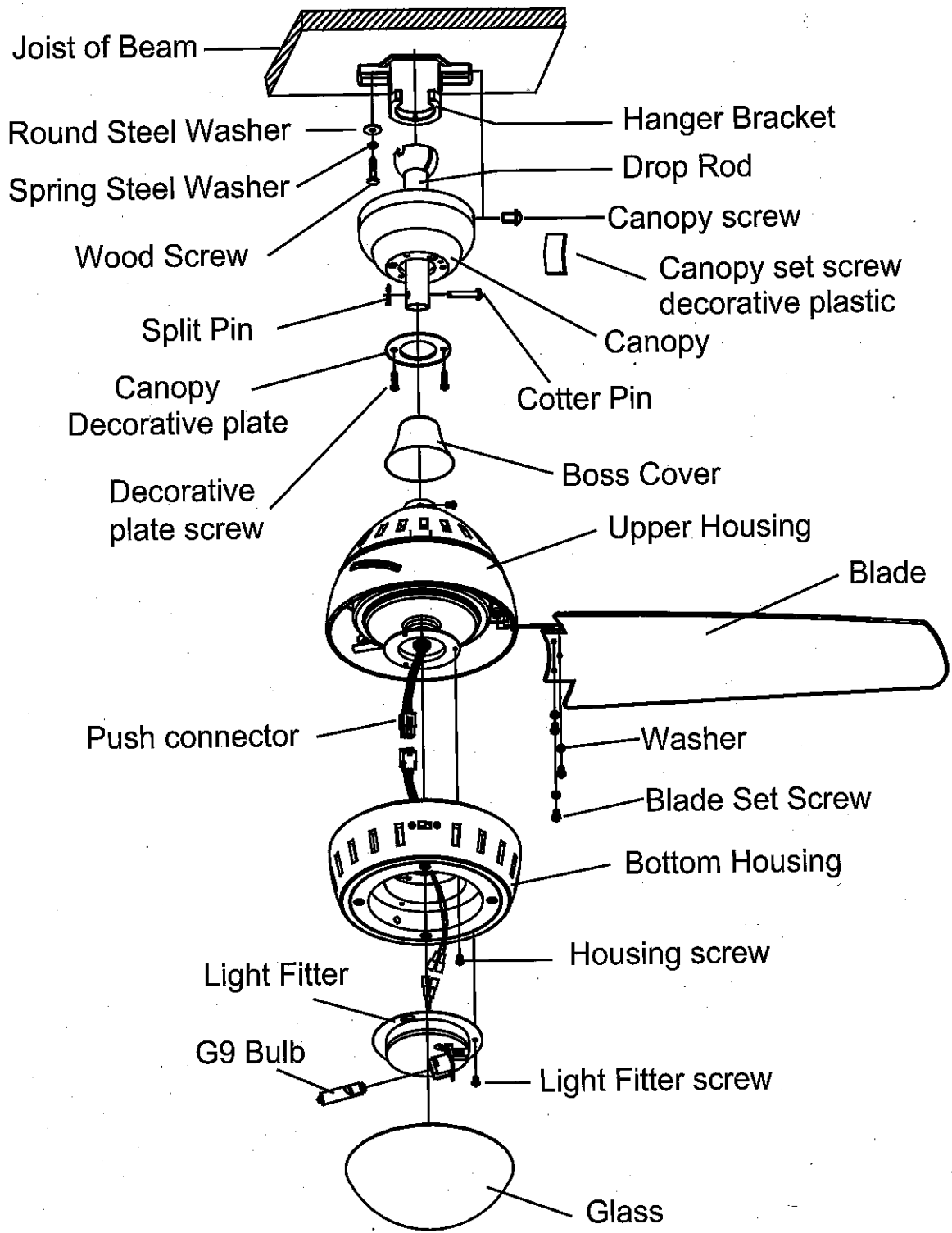

Installing the fan

All electrical work should only be undertaken after disconnection of the power by removing fuses or turning off the circuit breaker to ensure all pole isolation of the electrical supply.

Your fan can be installed in either of two options. It can be installed as a flush mount fan (Picture B), i.e. it is mounted as close to the ceiling as possible. It can also be installed as a drop rod style of fan (Picture A). In this situation the drop rod assembly is used to lower the fan down from its mounting position slightly. Extension rods, ranging from 12" to 72" (your fan is supplied with 6" Drop rod in the box), are available if you need to lower your fan further. (This is normally the case in conservatories or rooms with very high ceilings.)

Rods can be trimmed if necessary. If trimming is required cut excess from the bottom of the rod and re-drill a hole for the cotter pin.

Picture A
Drop Rod Style

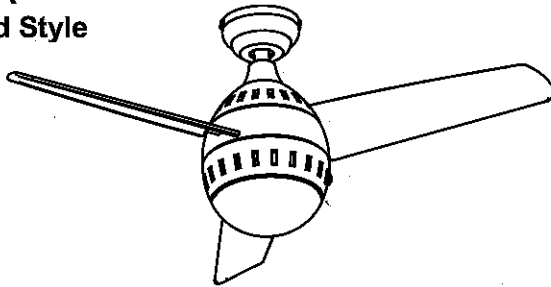

Picture B
Flush Mount Style

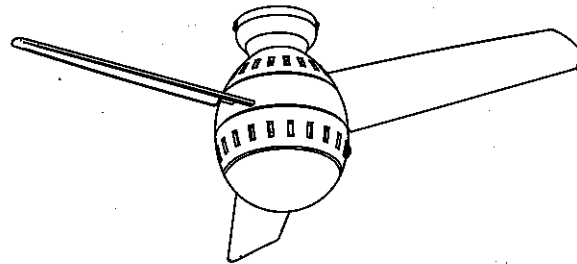

The following steps will guide you to a successful installation:

1. Hanging bracket installation
2. Down rod assembly style or flush mount assembly
3. Attaching the blades
4. Attaching bottom housing and light fitter
5. Remote Control and Wiring instructions
6. Installing shade

1. Hanger bracket installation

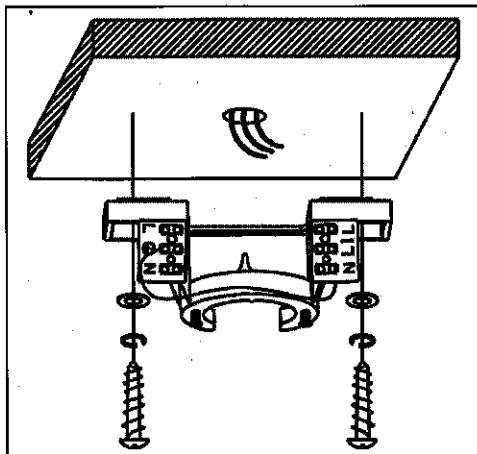

The hanging bracket should be screwed on to a firm flat surface. The fixing location must be able to withstand ten times the static weight of the fan. If you have any doubts as to the ability of your intended fixing location to be able to with stand this loading please contact our service help-line or another competent authority to advise you. In most situations two wood screws screwed in to a wooden joist is more than adequate to support your ceiling fan

The hanging bracket should be screwed onto the joist with the two wood screws provided. The washers provided should go in the following sequence:

Screw head > Steel round washer > Spring steel washers > Hanging bracket > Ceiling.
Screw the hanging bracket to the ceiling and make sure all connections are secure to prevent the fan from falling. Fixings must screw into a joist and not just the plasterboard. Leave two of the canopy screws, opposite each other, loose in their holes in the hanging bracket but store the other two safely.

2. Drop rod assembly

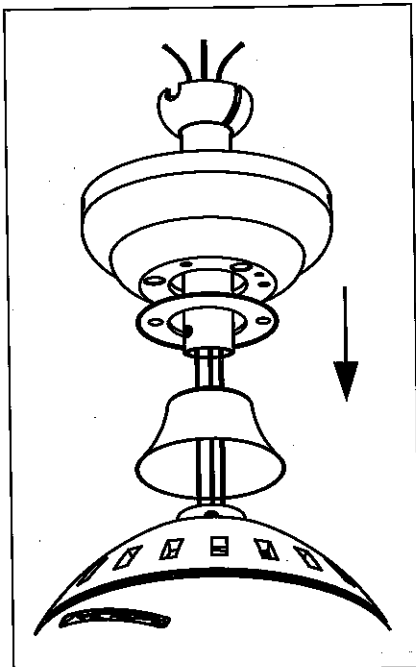

Remove the cotter pin and cross pin from the drop rod boss of the fan. If a longer drop rod (12" to 72" rod) is going to be used transfer the ball joint and the earth wire to the longer rod.

Put the drop rod through the flared end of the canopy and pass the electrical supply leads from the top of the motor through the drop rod and boss cover and canopy decorative plate until they exit at the top of the rod. Always ensure the rod passes through the canopy and boss cover before the rod is connected to the fan. If an extension rod longer than 18" inches is to be used, the cables will need to be extended in an appropriate way.

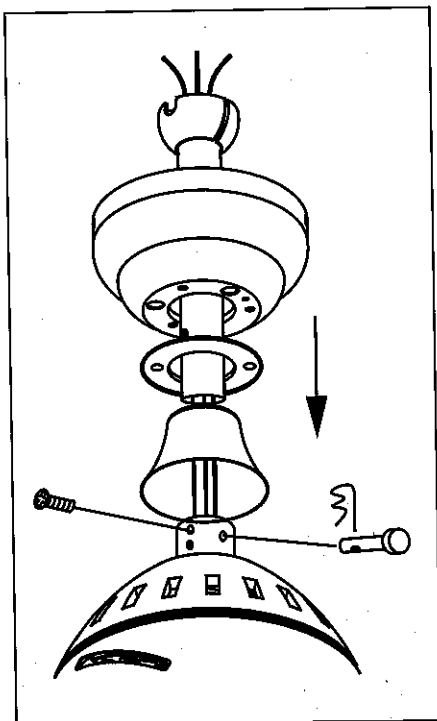

Loosen the drop rod set screws on the boss, which is on top of the motor and insert the drop rod into the drop rod boss on top of the motor casing. Turn gently to align the holes in the boss with those in the rod. Ease the split pin through the boss and the rod taking care not to pinch or damage any cables. Fix in place by replacing the cotter pin.

Tighten all set screws at this point. This prevents the rod and the fan moving in relation to one and other. It also assists in maintaining a good earth continuity through the fan, which is important to the safety of the unit.

Failure to tighten the locking screws down may cause the motor to oscillate badly.

2-1 Flush mount assembly

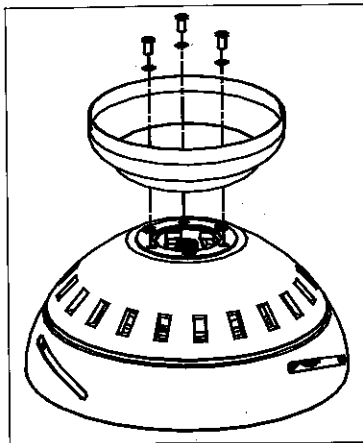
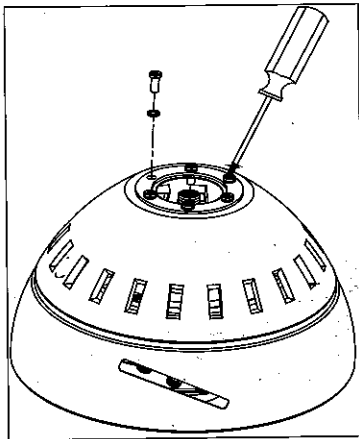

Release 3 screws from upper housing, put the canopy onto the drop rod boss of the fan. Using the 3 upper housing screws to screw the canopy tight Please refer to the pictures .

3. Attaching the blades

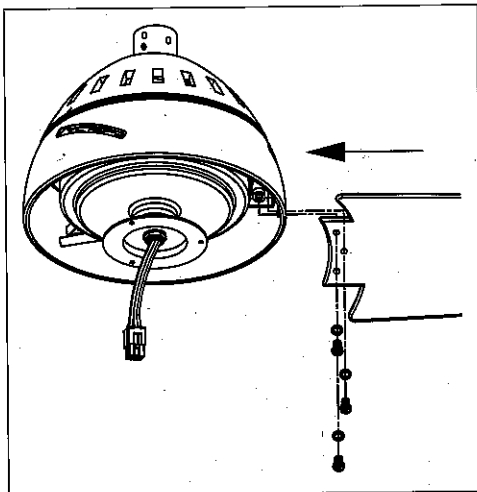

Unpack plastic blade (3pcs/set), put the plastic blade onto the motor. Pass the blade through the slot in the casing. Align with the holes on the motor. Please note: the blade can only be fitted one way. Using the screws and fiber washers provided to screw them firmly.

4. Attaching the bottom housing and light fitter

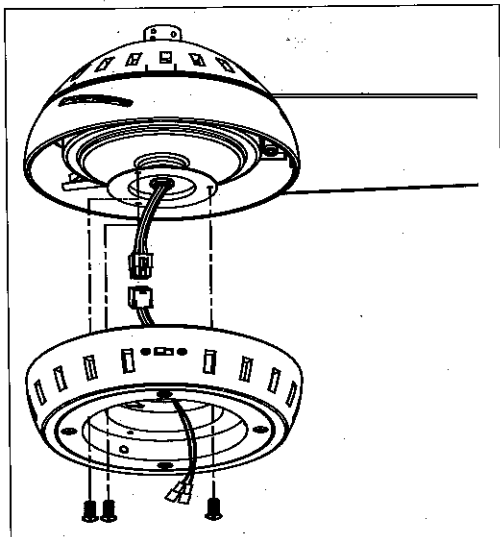

Connect the push connector of the fan to the push connector from the bottom housing, Use the three screws provide to screw the bottom housing firmly to the main assembly.

Please ensure the screws are tightened up firmly

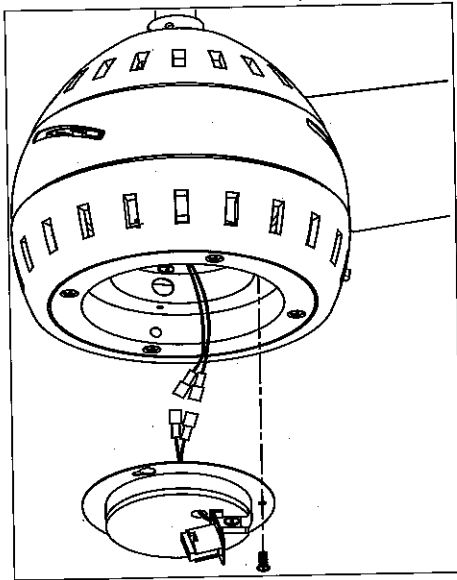

Connect the wires for the light fitter coming from the bottom housing to the light wires of light fitter. Using three screws provide to screw the light fitter firmly.

Please ensure the screws are tightened up firmly

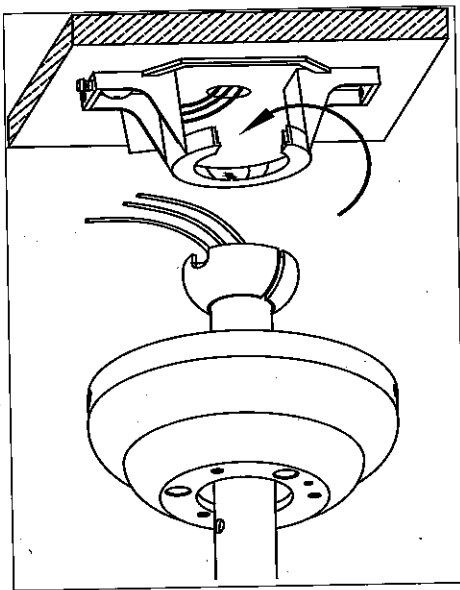

FOR DROP ROD STYLE OF FAN:

Lift the fan up to the hanger bracket, steer the ball in from the side of the bracket and lower it into the recess of the bracket.

Rotate the ball around until the groove in the side of the ball aligns with the protrusion on the upper edge of the recess. When aligned the fan should drop slightly as it assumes it's correct position.

This is to prevent rotation of the rod and fan when the unit is working.

REFER TO THE WIRING INSTRUCTIONS NEXT.

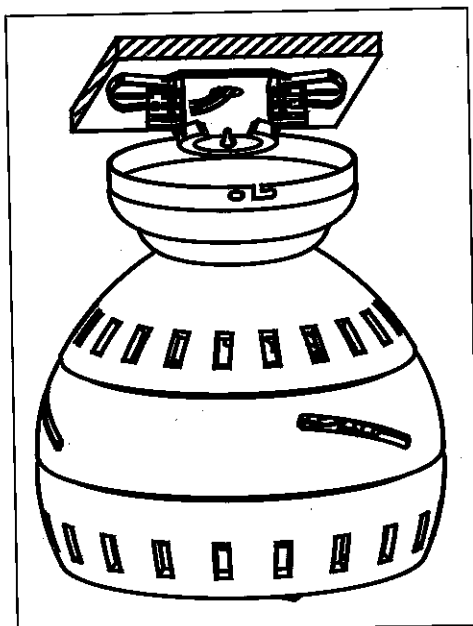

FOR FLUSH STYLE OF FAN:

Remove decorative plate screws from hanger bracket, hang the motor on hanging bracket with temporary support (a hook) for wiring connection. PLEASE TAKE CARE THAT THE FAN DOESN'T FALL

REFER TO THE WIRING INSTRUCTIONS NEXT.

5. Remote Control and Wiring Instructions

RECEIVER

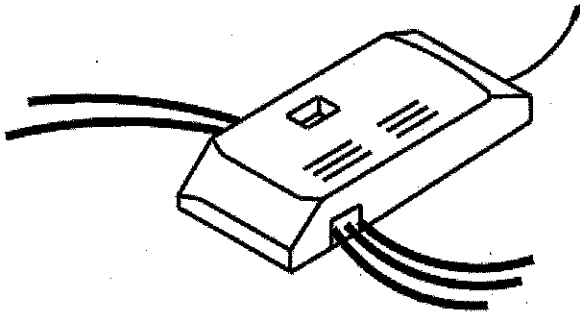

TRANSMITTER

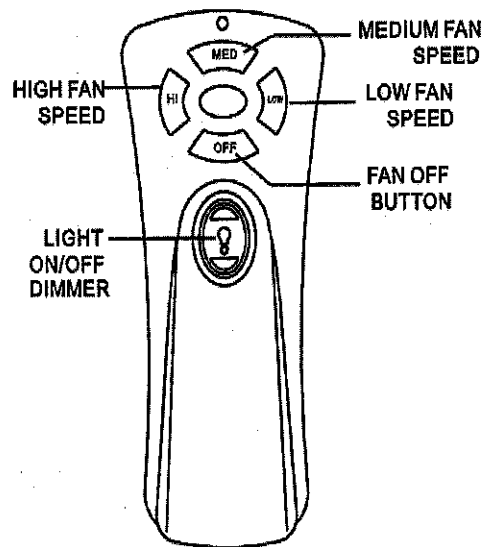

Your fan is supplied with a radio frequency remote control unit, and the fan does not have a pull switch for speed control, the fan can only be controlled by remote control. You can find the unit in the box. The above are the pictures of receiver and transmitter. Before connecting the wiring, please set up the code of remote control.

CODE SWITCH: Codes are set by pushing dip switches up or down. It is imperative that the code used for both transmitter and receiver is exactly the same, otherwise the remote control will not work. Please note the code switch will enable you to operate a second remote controller independently. For example, if you have two ceiling fans with 2 remote control units, set 2 different codes for each set of transmitter/receivers. This means you can operate each ceiling fan independently. Please see following drawing.

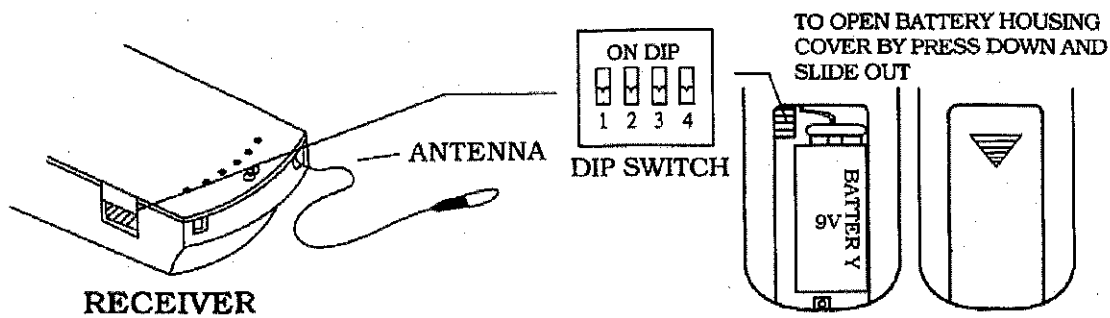

Please refer to instruction of remote control for more information.

PLEASE NOTE :

Before installation ensure that the electricity supply is disconnected and that all wiring is carried out in accordance with I.E.E. Regulations, current good practice, national and local electrical codes. Improper installation may result in an electrical short and may void your warranty.

IMPORTANT : THIS APPLIANCE MUST BE EARTHED.

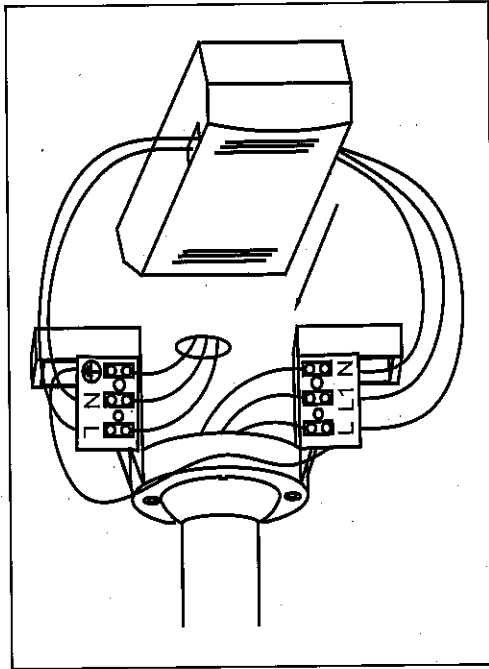

Put the receiver of remote control through hanger bracket (as picture).

Connect the A.C. power supply wire that come from the ceiling to the Brown and blue wire of receiver which is mark with label "L" & "N". In most cases, BROWN/RED wire is LIVE is connected to "L" BROWN wire, BLUE/BLACK wire is NEUTRAL is connected to "N" BLUE wire. GREEN/YELLOW wire is EARTH.

Connect the 4 lead wires coming from the fan housing with 4 wires coming from the other side of the remote control receiver where indicated sticker with brown, blue, orange block.

BROWN TO BROWN (Live wire of fan)
 BLUE TO BLUE (Neutral wire of fan)
 ORANGE TO ORANGE (Live wire of light)
 GRN/YEL TO GRN/YEL (Earth wire)

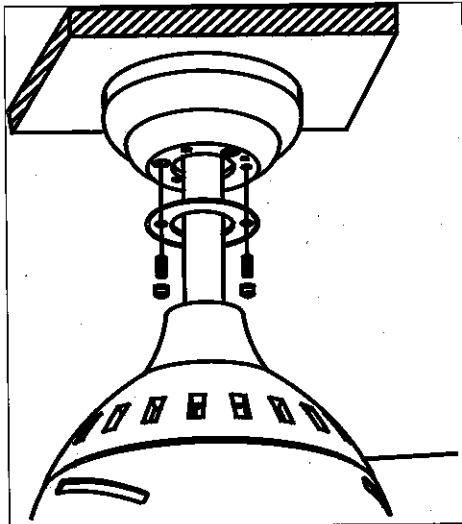

FOR DROP ROD STYLE OF FAN:

Once the cables of the remote control and fan have been connected offer the canopy up to the hanging bracket, and insert the canopy decorative plate to canopy, using knurled nut to screw the plate tight. Tighten all the screws to ensure a good safe fixing.

It is important to fix the canopy properly as this offers another level of safety should anything happen to the hanging bracket.

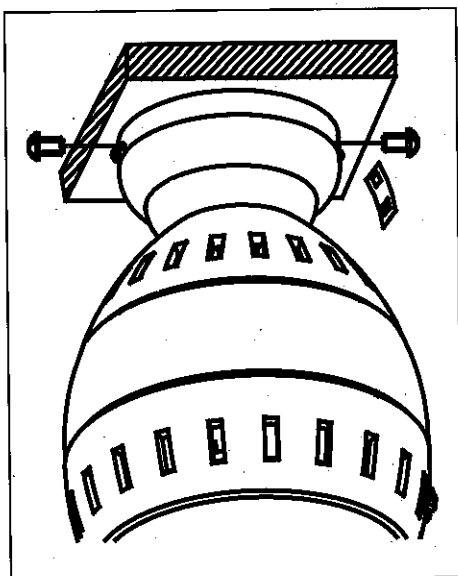

FOR FLUSH STYLE OF FAN:

Once the cables of the fan have been connected offer the canopy up to the hanging bracket. Please remove the canopy set screw decorative plastic from canopy and insert the screws in the hanging bracket. Tighten all the screws to ensure a good safe fixing.

It is important to fix the canopy properly as this offers another level of safety should anything happen to the hanging bracket.

6. install bulb and shade

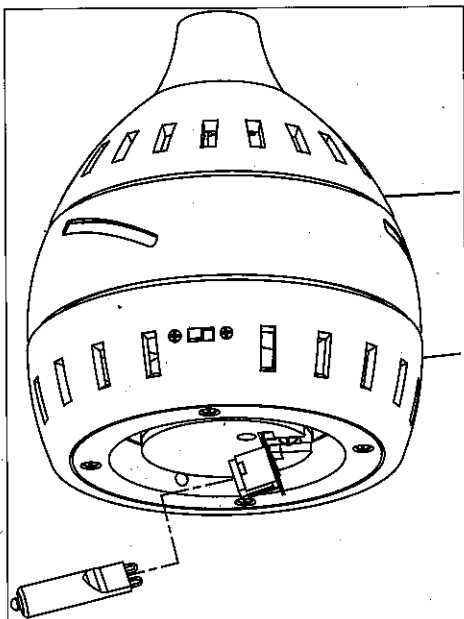

You must not touch new bulb with bare fingers. The body oil residue may cause the bulb to explode. Use tissue or cloth to protect the new bulb from your fingers.

Before installing the bulb, make sure the power is disconnected. Put the G9 60W Max. bulb into the socket in the fitter. Turn on the power and push the light button on the transmitter to check the bulb is working well.

Now is a good time to test that the fan and remote control operate correctly. Turn on the power and use the transmitter to Control your fan, checking the fan speeds and light kit work properly.

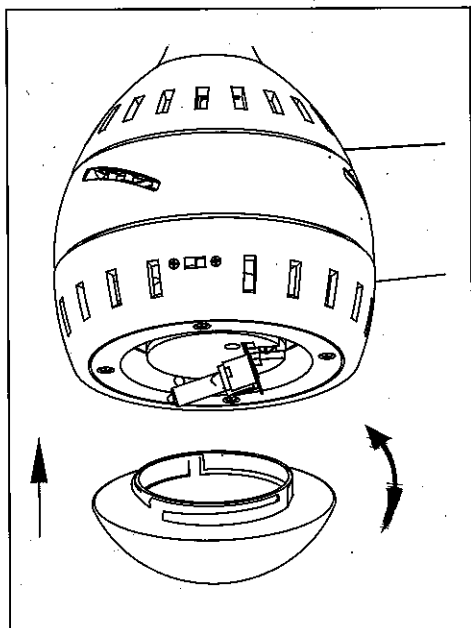

After checking all the functions are worked properly, replace the shade into the light fitter and twist it tight. Ensure the shade is tighten firmly, the shade will drop off and broken if it is not installed properly .

Now, your fan installation is complete.

Product Disposal Instructions

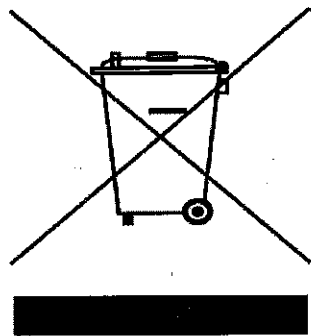

This product has been classed as Electrical or Electronic Equipment and should not be disposed of with other household or commercial waste at the end of it's working life.

The Waste of Electrical and Electronic Equipment (WEEE) Directive (2002/96/EC) has been put in place to recycle products using best available precise and minimize the impact upon the environment.

Operating instructions

Having checked that all electrical connections are securely made and insulated, turn on the power and check the operation of the fan.

The slide switch on the other side of the housing changes the direction of rotation of the blades. (Remember to let the fan slow to a complete stop before changing the direction of rotation). When looking up at the fan blades, anti-clockwise rotation achieves a downward flow of air and clockwise rotation achieves an upward movement of air.

Summer operation – In warm weather a downward movement of air is more desirable as this achieves a greater cooling effect.

Winter operation – In winter a movement of air moving upwards and then back down the sides of the room achieves a more balanced temperature throughout the room.

If a wall control or remote control system has been used refer to the accompanying leaflets enclosed in these systems.

Blade balancing

Whilst every precaution is taken at the factory to ensure your fan is of the highest quality, imbalance may occur. This may be due to slight irregularities in the blades or blade carriers. Deviating from these instructions can cause further problems.

The following procedure may help to rectify the situation.

The hanging bracket must always be tight against the ceiling so that no movement can occur.

Make sure that the rod is firmly locked into the boss on top of the fan. The locking screw should be securely tightened.

Check all the blades are firmly tightened on to their fixings.

Blade tracking can easily be checked by holding a yardstick or similar measure vertically from the ceiling to the tip of the blade. Then check all blades measure the same distance from that point. To correct slight problems re-check the screws that hold the blades onto the motor for tightness.

Changing over two adjacent blades – may correct any imbalance.

Use the universal balancing kit supplied with the fan.

Please note that drop rod styles of fans do have a slight level of movement but this is in no way dangerous.

Care and cleaning

Ensure that checks of the fixings take place periodically. (see Safety Precaution 11)

Periodic cleaning of your new fan is recommended particularly the blades. The plated or painted surfaces of your fan have been sealed with a lacquer to minimize any discoloration or tarnishing. Therefore use a soft brush or lint free cloth to avoid scratching the surface.

The motor has permanently sealed bearings so no lubrication is necessary

Do not use water when cleaning you fan as this could damage the surfaces of the casing and the blades and may create the possibility of a electric shock.

Ceiling Fan Warranty.

You must have the original purchase receipt or bill of sale to make a warranty claim. No claim will be accepted unless proof of date of purchase is available at the time of making the warranty claim.

Ceiling Fan Warranty Period.

The ceiling fan itself, excluding accessories such as the Remote Control Transmitter and Receiver, is covered by a 5 year warranty. During this period, Fantasia Distribution Ltd will, at its discretion, repair or replace defective product. During this 5 years, the owner is responsible for labour costs incurred in removing and re-installing the fan, and for transport costs to Fantasia Distribution Ltd's repair centre. Return freight will be paid by Fantasia Distribution Ltd. The cost of obtaining or using special access equipment (scissor lifts, scaffolding etc.) is specifically excluded, and it is the responsibility of the owner to provide such equipment and have it safely installed and operated.

Remote Control Warranty Period.

Fantasia Distribution Ltd's Remote Control Receivers and Transmitters (Handsets) are covered by a 2 year repair or replacement warranty

Balance of Warranty on Repaired or Replaced Products.

Any replaced or repaired product is covered only by the balance of the warranty remaining on the original article.

Transfer of Warranty.

If the dwelling where the fan or remote control is installed changes hands, the balance of the warranty passes to the new owner, providing the original bill of sale for the product is retained by the new owner.

Warranty for the fan does not cover damage to the fan if it is moved from one dwelling to another during the warranty period. The warranty is voided in total if the product is sold as second hand goods.

The following is NOT covered by warranty.

1. Any damage incurred after delivery to the owner that is not caused by a fault in the products materials or workmanship; damage from lightning or power surges; incorrect installation; damage due to incorrect installation; water damage of any kind; installation or use outdoors; damage arising from connection to or use with alternative power systems (e.g. inverters, solar, etc.).
2. Ceiling fans not installed by a qualified electrician.
3. Repair of a ceiling fan used incorrectly, accidentally damaged, modified in any way or not serviced in accordance with the maintenance instructions.
4. The cost of transporting and insuring the ceiling fan between the nearest Fantasia Distribution Ltd agents' service depot and its normal location. These costs must be met by the purchaser
5. Subject to any statutory provisions to the contrary, claims for damage to furniture, carpet, walls, ceilings, foundations or any other consequential loss either directly or indirectly resulting from a faulty ceiling fan.
6. The Ceiling Fans not purchased and installed in Mainland UK.
7. A service fee will be charged where; there is nothing wrong with the ceiling fan or; the defective operation of the ceiling fan is due to failure of electricity or; the installation is not in accordance with Fantasia Distribution Ltd instructions and/or applicable local regulations or; the defects have been caused by incorrect application or abuse of the ceiling fan or; the damage has been caused by unauthorized persons attempting to repair the fan.

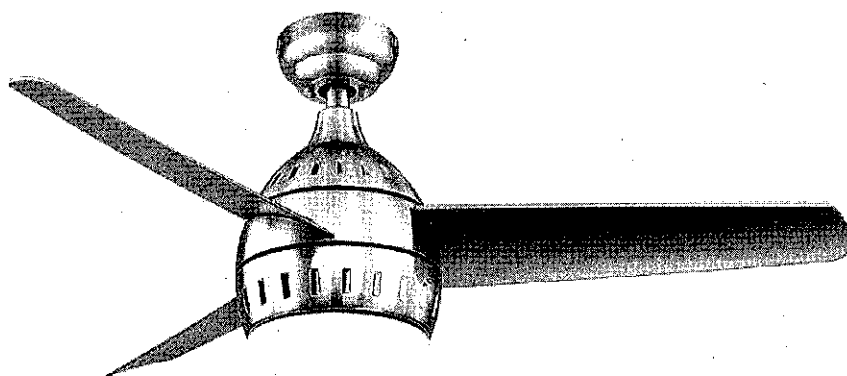

42"/106cm

Atom

Alternatively please go to our website www.fantasiaceilingfans.com and fill in the warranty section there.

FANTASIA DISTRIBUTION LTD.

Unit B. The Flyers Way, Westerham, Kent, TN16 1DE

Tel : (01959) 564 440 Fax : (01959) 564 829

E-MAIL: info@fantasiaceilingfans.com