



OWNERS INSTRUCTION MANUAL

106CM/42"

Mayfair Combi

- **INSTALLATION**
- **OPERATION**
- **MAINTENANCE**

CAUTION

READ INSTRUCTIONS CAREFULLY FOR SAFE
INSTALLATION AND FAN OPERATION. IF UNSURE CONSULT
A QUALIFIED ELECTRICIAN

SUITABLE FOR 230V/50 CYCLE ELECTRICAL SUPPLY
Enquiries on installing your fan please call our help line on

01959-564440

Safety Precautions

1. To ensure the success of the installation be sure to read the instructions and study the diagrams thoroughly before commencing.
2. All electrical work should only be undertaken after disconnection of the power by removing fuses or turning off the circuit breaker to ensure all pole isolation of the electrical supply. If you are in any doubt the services of a qualified electrician should be sought to ensure that all work is carried out in accordance with the I.E.E. Regulations, current good practice and other national and local electrical codes.
3. Make sure that your installation sits will not allow the rotating fan blades to come into contact with any object and that there is a minimum clearance of 150mm (6") from the blade tip to the wall or ceiling. Please note that the bigger this clearance is the better the airflow from your fan will be. Ensure the blades are mounted at a minimum height of 2.3 meters (7'6") from the floor when the fan is installed.
4. The fixing point for the fan must be able to support a weight of ten times that of the net weight of the fan. Net weights can be found on the bottom of the unit's box. If you are mounting the fan to a ceiling junction box, the box and it's fixing must be able to support the moving weight of the fan and must not twist or work loose.
5. The fan must be earthed.
6. Do not connect the fan motor to a dimmer switch. This may give an unsatisfactory performance (motor hum) and cause damage to the motor.
7. It is not recommended that ceiling fans and gas appliances are operated in the same room at the same time.
8. The fan must be turned off and stopped completely before reversing the fan direction. This will prevent any damage to the motor of the unit or controller (if installed).
9. Do not insert anything into the fan blades while the fan is operating. This will damage the blades and upset the balance of the unit causing the unit to wobble.
10. After the fan is completely installed make sure that all connections are secure and tight to prevent any problems.
11. Because of the fan's natural movement, some connections may loosen. Check the support connections, brackets and blade attachments twice a year to make sure they are all secure. If they are loose tighten with a screwdriver. (It is not necessary to take the fan down from the ceiling)

Note : The important safeguards and instructions given in this manual are not meant to cover all possible conditions and situations that may occur. It must be understood that common sense, caution and care are factors which cannot be built into any product. These factors must be supplied by the persons caring for and using the unit.

For installation advice, or in the unlikely event of damaged or missing parts please ring:

HELPLINE : (01959) 564 440

Supplied Parts

- One fan motor assembly
- One round plate fitted with terminal block and top rubber washers.
- One set of blades
- One set of blade carriers
- One screw-pack with balancing kit
- One optical clothe
- One installation booklet.
- One 3 light Gu-9 cluster halogen light kit
- Three Gu-9 light bulb

Tools and Materials Required

- Philips screwdriver
- Blade screwdriver
- Small electrical screwdriver
- Electrical pliers
- Step ladder
- Wiring supplies as required by current electrical practice
- Bulbs if a light fitting is fitted / to be fitted
- In-line crimps or other suitable connectors if an extension rod in excess of 760mm (30 inch) is to be fitted.

Before starting the assembly and installation of your fan please ensure the safety precautions have been read and understood.

Installation Difficulties, Missing or Damaged Parts

If you have any difficulty in installing your fan/light or if you are unfortunate enough to find that your fan have been dispatched with parts missing or damaged please contact our help-line on (01959 564440). We will be very pleased to provide help or forward replacements parts to your immediately.

In any communication with us please quote model reference, colour of the unit and the part missing /damaged.

**HELPLINE
01959 564440**

Parts names and their relative positions

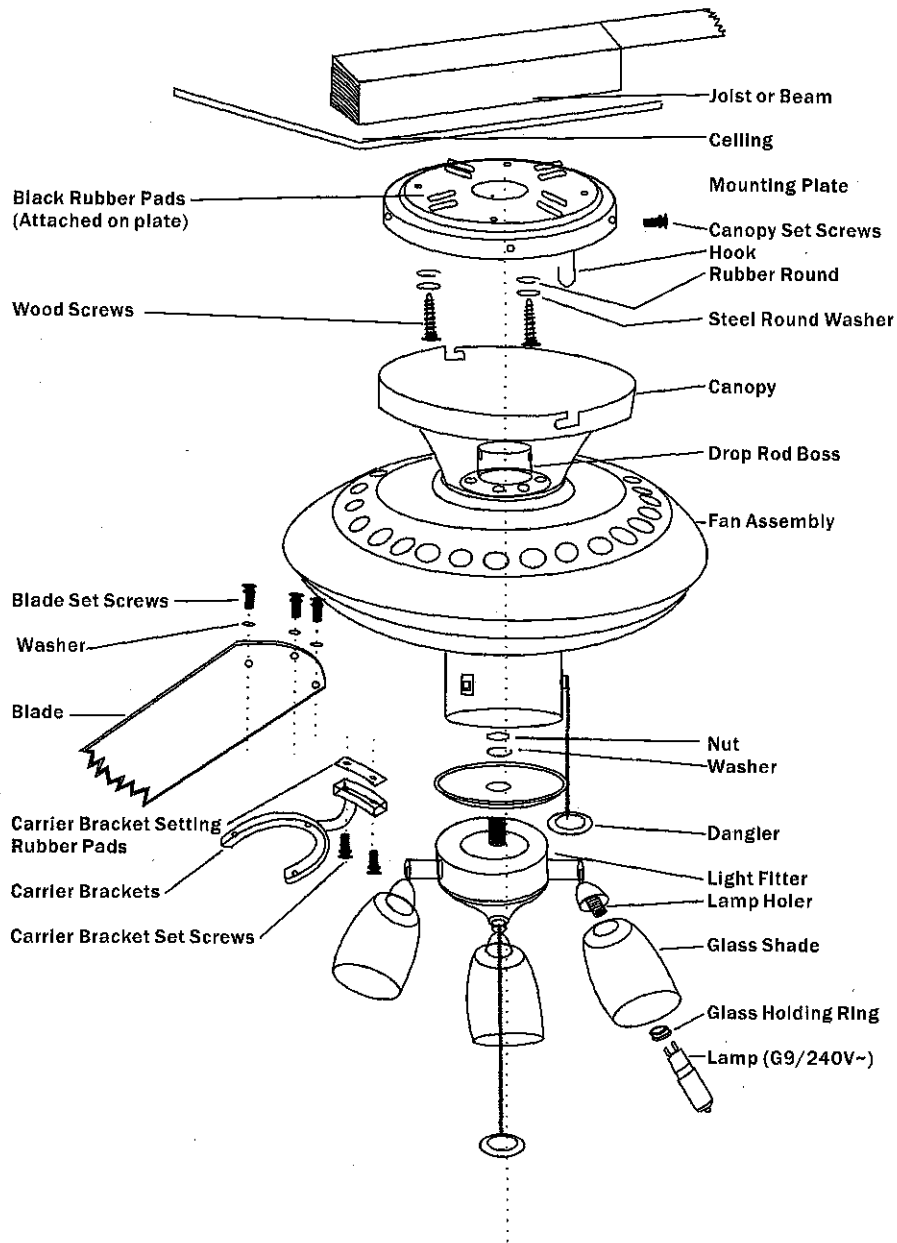

The following steps will guide you to a successful installation:

1. Mounting plate installation
2. Attaching light kit
3. Flush mount assembly
4. Wiring instructions
5. Blade assembly
6. Attaching the blades

1. Mounting plate installation

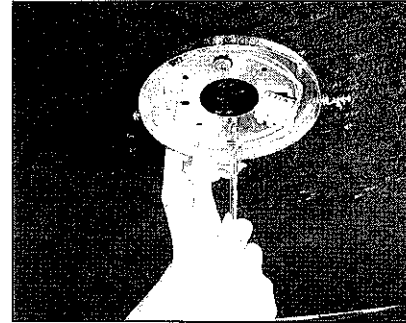

The mounting plate should be screwed on to a firm flat surface. The fixing location must be able to withstand ten times the static weight of the fan. If you have weight of the fan. If you have your intended fixing location to be able to withstand this loading please contact our service help-line or another competent authority to advise you. In most situations four wood screws screwed in to a wooden joist is more than adequate to support your ceiling fan. The mounting plate should be screwed onto the joist with the two wood screws provided. The washers provided should go in the following.

Screw head > Steel round washer > Black rubber round washer > Mounting plate > Ceiling. Screw the mounting plate to the ceiling and make sure all connections are secure to prevent the fan from falling. Fixings must screw into a joist and not just the plasterboard. Leave two of the canopy screws, opposite each other, loose in their holes in the mounting plate but store the other two safely.

2. Adding Light Kit

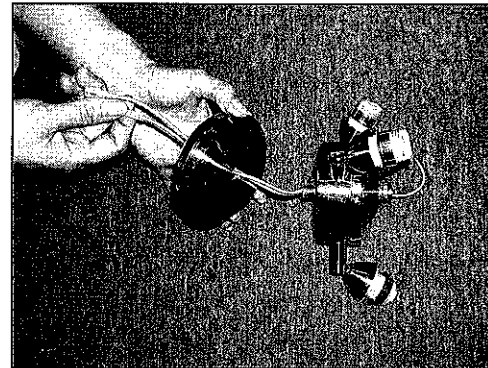

To install the Gu-10 cluster light kit first ensure all poles disconnection of the electricity supply. Then unscrew the three screws at the bottom of the switch housing and remove the switch housing plate. Your light fitting will either replace this plate entirely or will connect on to the plate via the push out centre stud. The light is then offered up to the switch housing plate.

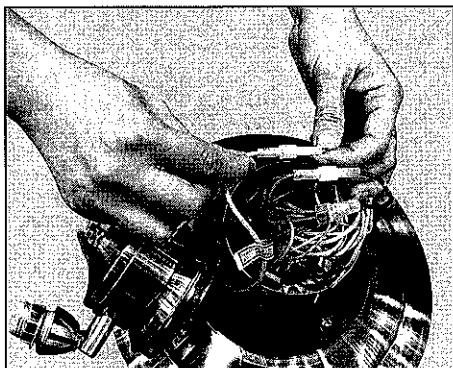

Locate the two cables marked "for light". Connect the blue and orange cables with their corresponding colour cables on the light fitting. The orange wire is the 'live' supply for the light and the blue wire is the 'neutral'. The connection is made with push together connectors.

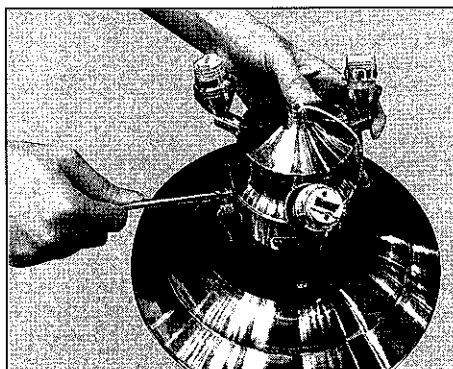

After connecting the wire of fan and light, up the switch housing plate and light kit back to switch housing of fan. Use the three screws to make it tighten. Please ensure the screws is tighten enough. The light kit will be falling down if it is not tighten firmly.

When assembling the lighting attachment back onto the fan ensure there are no cables trapped between the metal surfaces. Also ensure that there are serrated washers on the three screws at the bottom of the switch housing. This ensures good earth continuity to the light.

3. Flush Mount Assembly

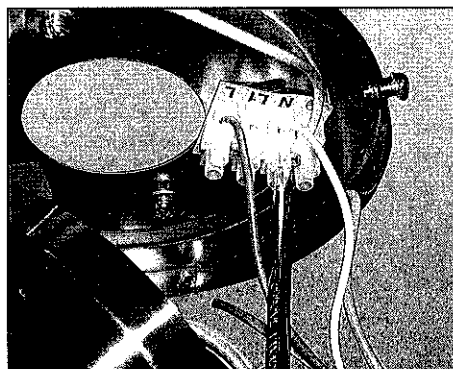

After following the mounting plate and light kit assembly installation instructions.

Offer the fan up to the mounting plate.

Hang the fan temporarily on the hook found on the mounting plate using one of the holes in the ceiling canopy (do not use the keyed holes)

Connect the wiring as shown in the following wiring instructions.

4. Wiring Instructions

The fan now requires to be connected to your household supply in accordance with diagrams 1-6.

Please note:

Before installation ensure that you have all pole disconnection of the electricity supply and that all wiring is carried out in accordance with I.E.E. Regulations, current good practice, national and local electrical codes. Improper installation may result in an electrical short and may void your warranty.

IMPORTANT: THIS APPLIANCE MUST BE EARTHED.

Ways of wiring your fan

1. Fan only operated by pull switch (no wall switch)

Connections Brown supply on the fan is connected to the Live supply (normally red) Blue supply is connected to the neutral supply (Black) Green/Yellow earth lead is connected to the Earth supply (Green/Yellow), Connect the Orange supply to the L2 terminal and just leave it there For further optional connection.

Operation The fan speed is controlled by the pull switch on the appliance

See Diagram 1

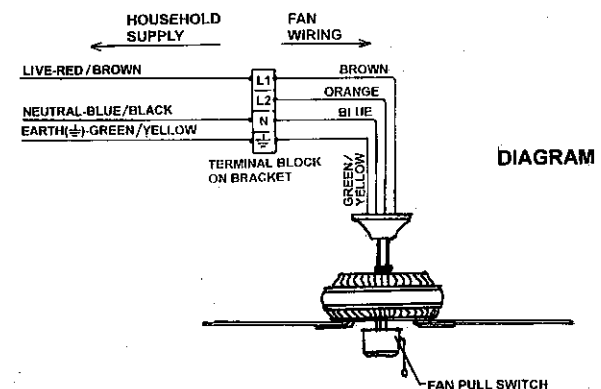

2. Fan & Light both operated by pull switches (no wall switches)

Connections: Brown & Orange supplies on the fan are connected to the Live supply (normally Red) Blue supply is connected to the Neutral supply (Black) Green/Yellow earth lead is connected to the Earth supply (Green/Yellow)

Operations The fan & light are controlled by the pull switches on the appliance. Both units can be operated independently.

See Diagram 2

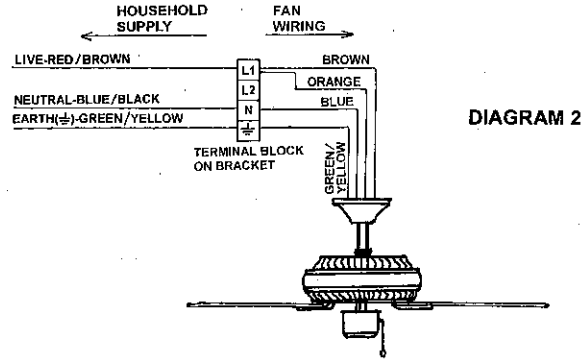

3. Fan & Light sharing a supply from a wall switch

Connections : Brown & Orange supplies on the fan are connected to the Switched Live supply (normally Black but marked as a live supply with red sleeving.) Blue supply is connected to the neutral supply (Black) Green/Yellow earth lead is connected to the Earth supply (Green/Yellow)

Operations The fan & light are controlled by the pull switches on the appliance. The wall switch will switch the supply to whole of the appliance. The wall switch must be an on/off type. Do not use a dimmer switch. Both units can be operated independently.

See diagram 3

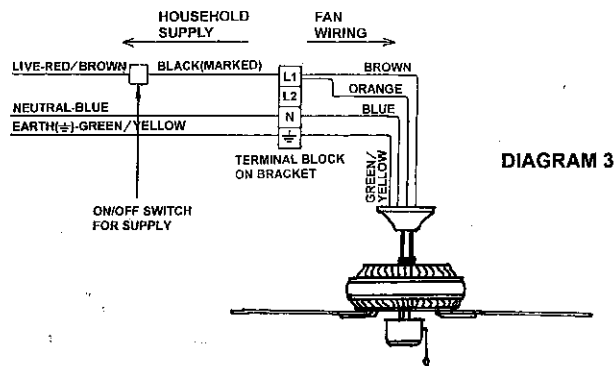

4. Wall switch operating the light, pull switch operating the fan.

Connections Brown supply on the fan is connected to the Permanent Live Supply (Red), Orange supply is connected to the Switched Live Supply (normally Black but marked as a live supply with red sleeving). Blue supply is connected to the neutral supply (Black), Green/Yellow earth lead is connected to the Earth supply (Green / Yellow)

Operations The fan is controlled by the pull switch on the appliance. The wall switch will switch the light. A normal on/off or dimmer switch can be used here.

See diagram 4

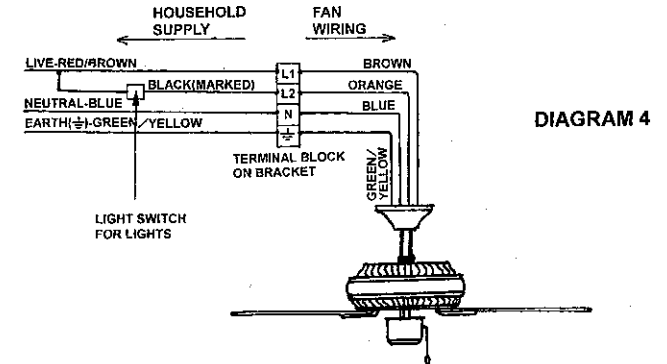

5. Wall switch operating the fan, pull switch operating the light.

Connections Orange supply on the fan is connected to the Permanent Live supply (Red). Brown supply is connected to the Switched Live supply (normally Black but marked as a live supply with red sleeving). Blue supply is connected to the Neutral supply (Black), Green/Yellow earth lead is connected to the Earth supply (Green/yellow).

Operations The light is controlled by the pull switch on the appliance. The wall switch will switch the fan. A normal on/off or wall mounted speed control can be used here. A dimmer switch can not be used.

See diagram

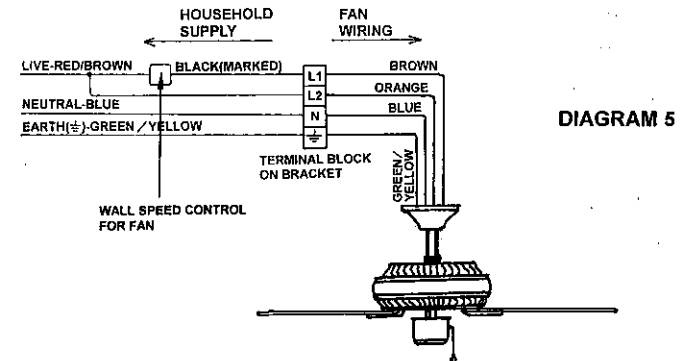

6. Wall switches operating the fan and the light

- Connection** Orange supply on the fan is connected to the Switched Live supply No. 1. Brown supply is connected to the Switched Live supply no. 2. Note : The type of installation requires two switched lines so a 'three core + earth' cable is required. Blue supply is connected to the Neutral supply (Black) Green/yellow earth lead is connected to the Earth supply (Green/Yellow)
- Operations** The light is controlled by the wall switch. The fan is controlled by the wall switch. Two switches are used here. A normal on/off or dimmer switch can be used for the light. A normal on/off or wall mounted speed control can be used for the Fan.

See Diagram 6

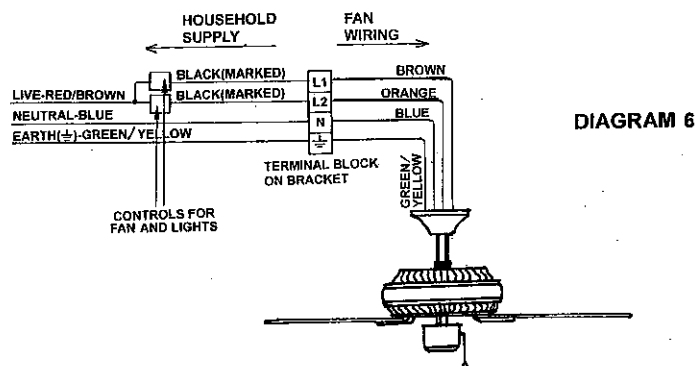

Do not connect the motor supply cable to a dimmer switch. If a wall mounted control for the fan is required then we recommend you contact our help-line.

It is possible to control your fan and light with a remote control system. For further details please contact the help-line.

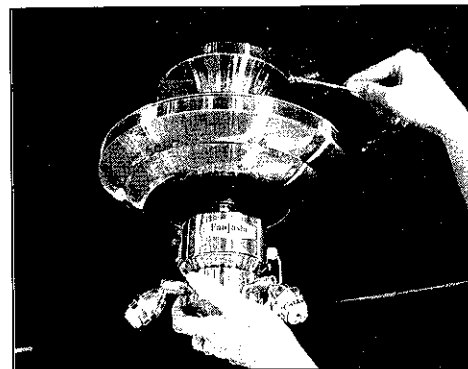

Take the weight of the fan and offer the canopy up to the mounting plate. Two keyed slots in the canopy will align with the two screws that have been left in the mounting plate.

Life the fan and twist the canopy. This will now take the weight of the fan. Promptly insert the two remaining screws in the mounting plate. Tighten all four screws to ensure a good safe fixing. Now is a good time to test that the fan operates correctly.

With the power switched on check that the fan operates in both directions and that there is a difference in speed (this won't be exact as the blades are not installed yet).

If all is well proceed with the rest of the installation. If a problem is experienced please refer to the fault find section at the back of this leaflet.

Connect the dangler to the end of the pull chains. If you require longer chain please call our help-line.

5. Assembling the blades

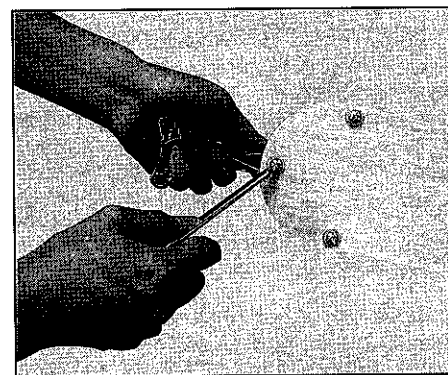

The blades now need to be assembled on to the carrier brackets.

Note that blades can be installed with either surface facing down.

Carefully unwrap the blade and a carrier bracket. Align the bracket with the holes in the blades and use the screws and fibre washers provided to connect them.

The fibre washer should go on top the blade between the head of the screw and the surface of the blade. Ensure the screws are tightened up firmly.

Repeat this process for all blades.

6. Attaching the assembled blades onto the fan

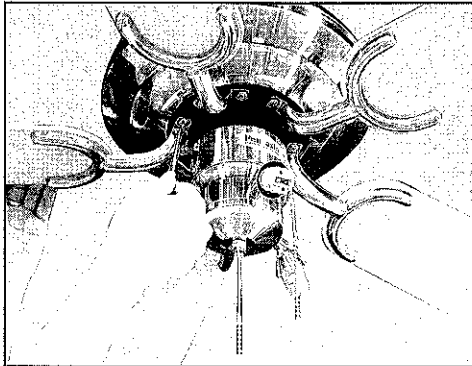

Using the motor screw and the spring washers provided, bolt the carrier bracket on to the motor. Ensure the bolts are tightened firmly.

Be careful not to bend the blades or the carrier brackets during installation as this may result in an imbalance and induce wobble.

If installing more than one fan be careful not to mix the blade sets.

Each set is carefully manufactured to be evenly balanced, mixing would break up a balanced set and again this could induce wobble.

7. Installing glass shade and light Bulb



Unpack the 3x60 Watts Max. G9 light bulbs that are supplied with the light kit. And inserts them into the lamp holder.

CAUTION: The G9 halogen bulb must not be touched directly by bare fingers. Use the bubble paper to hold the light bulb when inserting the light bulb into lamp holder.

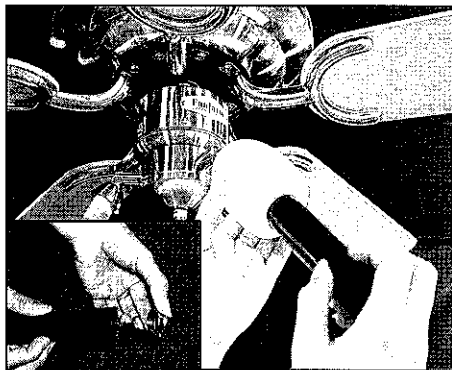

Release the glass holding ring from the socket, use the gray plastic pipe provided to hold the ring. Put the glass shade into the socket, put the holding ring back to the socket to tighten the glass. Please make sure it is tightened enough, maybe will cause the noisy if the glass didn't be tightened enough.

Operating instructions

Having checked that all electrical connections are securely made and insulated, turn on the power and check the operation of the fan. The pull switch on the side of the motor housing is the selection switch for the speed function of the fan and is also the on/off function. The first pull from the off position takes you on to the high speed; the second on to medium speed; the third on to slow speed and the fourth pull to the off position.

The slide switch on the other side of the switch housing changes the direction of rotation of the blades. (Remember to let the fan slow to a complete stop before changing the direction of rotation). When looking up at the fan blades, anti-clockwise rotation achieves a downward flow of air and clockwise rotation achieves an upward movement of air.

Summer operation – In warm weather a downward movement of air is more desirable as this achieves a greater cooling effect.

Winter operation – In winter a movement of air moving upwards and then back down the sides of the room achieves a more balanced temperature throughout the room.

If a wall control or remote control system has been used refer to the accompanying leaflets enclosed in these systems.

Blade balancing

Whilst every precaution is taken at the factory to ensure your fan is of the highest quality, imbalance may occur. This may be due to slight irregularities in the blades or blade carriers. Further problems can be caused by deviating from these instructions.

The following procedure may help to rectify the situation.

The hanger bracket must always be tight against the ceiling so that no movement can occur.

If the installation requires a rod style make sure that the rod is firmly locked into the boss on top of the fan. The locking screw should be securely tightened.

Check all the blades are firmly tightened on to their carrier brackets.

Check all the carrier brackets are tightened on to the motor firmly.

Blade tracking can easily be checked by holding a yardstick or similar measure vertically from the ceiling to the tip of the blade. Then check all blades measure the same distance from that point. To correct slight problems in the alignment of a blade, gently bend the carrier to bring it back in line.

Changing over two adjacent blades – may correct any imbalance.

Use the universal balancing kit supplied with the fan.

Please note that drop rod styles of fans do have a slight level of movement but this is in no way dangerous.

Care and cleaning

Ensure that periodic checks of the fixings takes place. (see Safety Precaution 11)

Periodic cleaning of your new Fantasia fan is recommended particularly the blades. The plated or painted surfaces of your fan have been sealed with a lacquer to minimize any discoloration or tarnishing. Therefore use a soft brush or lint free cloth to avoid scratching the surface.

The motor has permanently sealed bearings so no lubrication is necessary

Do not use water when cleaning your fan as this could damage the surfaces of the casing and the blades and may create the possibility of an electric shock.

Tips from Fantasia

If you have a false ceiling, connect the mounting plate on to the main structure and use an extension rod to lower the fan below the false ceiling. (Remember to allow adequate clearance for the rotating blades – see Safety Precaution 3).

The mounting plate can be mounted on to a surface up to 40°. The fan will have to be installed in the drop rod style of mounting for this (Remember to allow adequate clearance for the rotating blades – see Safety Precaution 3).

Do not forget to put the canopy on the rod before connecting the rod onto the fan.

Blades may be reversed so the alternative finish can be seen.

Extension chain is available if the control chains are not long enough, please ring the help-line for further details.

If you are installing more than one fan make sure that you do not mix the fan blade sets.

Fault Finding

Noise level unacceptable	Noises from fans are usually due to something being loose on the fan. As a first corrective measure ensure all screws are tight (including shade screws if a light is fitted)
Fan wobbles excessively	The blades may have imbalance. Follow the blades Balancing section. The drop rod boss set screws may not be locked tightly. Tighten and retry.
Fan will not rotate	Check supply connections. Check that the blades are not fouling anything
Light will not work	Check supply connections.
Fan is tarnishing	Check that no solvents have been used in the vicinity of the fan – especially floor adhesives and brick acids.

Installing Florence glass shade and G9 light bulb

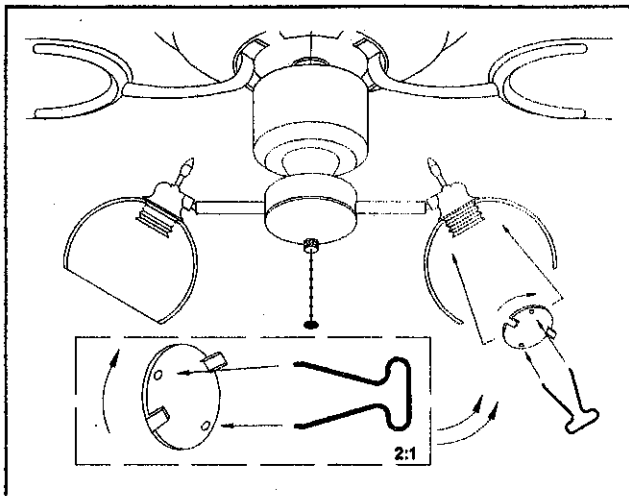

Release the glass holding ring from socket, use the tool (clip) provided to hold the ring. Please refer the above picture.

Put the glass shade into the socket, put the holding ring back to socket tighten the glass. Please make sure it is tightened enough, maybe will cause the noisy if the glass didn't be tightened enough.

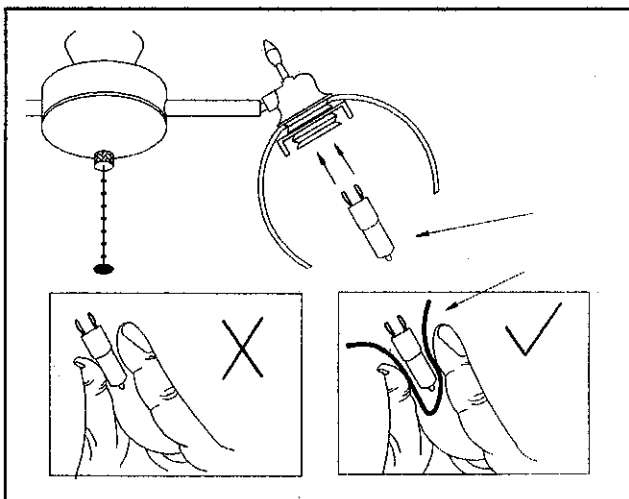

Unpack the 3x60 Watts Max. G9 light bulbs that are supplied with the light kit. And insert them into the lamp holder.

CAUTION: The G9 halogen bulb must not be touched directly by bare fingers. Use the bubble paper to hold the light bulb when inserting the light bulb into lamp holder.

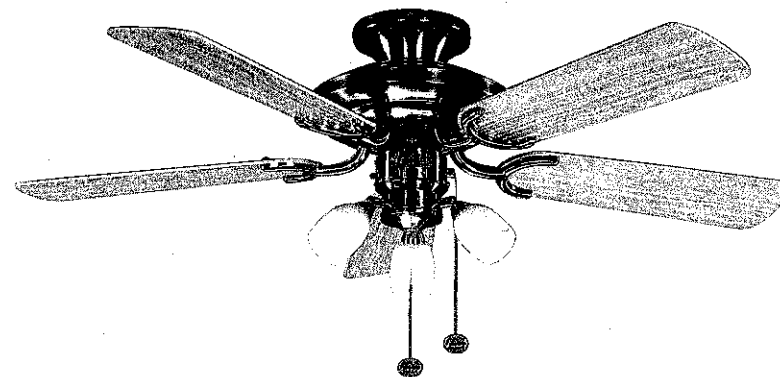

106cm/42"

Mayfair Combi

FANTASIA DISTRIBUTION LTD.

Unit B. The Flyers Way, Westerham, Kent, TN16 1DE

Tel : (01959) 564 440 Fax : (01959) 564 829

E-MAIL: info@fantasiaceilingfans.com