



## OWNERS INSTRUCTION MANUAL

106CM/42"

# Phoenix

- INSTALLATION
- OPERATION
- MAINTENANCE

### CAUTION

READ INSTRUCTIONS CAREFULLY FOR SAFE  
INSTALLATION AND FAN OPERATION. IF UNSURE CONSULT  
A QUALIFIED ELECTRICIAN

SUITABLE FOR 230V/50 CYCLE ELECTRICAL SUPPLY  
Enquiries on installing your fan please call our help line on

**01959-564440**

## Safety Precautions

1. To ensure the success of the installation be sure to read the instructions and study the diagrams thoroughly before commencing.
2. All electrical work should only be undertaken after disconnection of the power by removing fuses or turning off the circuit breaker to ensure all pole isolation of the electrical supply. If you are in any doubt the services of a qualified electrician should be sought to ensure that all work is carried out in accordance with the I.E.E. Regulations, current good practice and other national and local electrical codes.
3. Make sure that your installation site will not allow the rotating fan blades to come into contact with any object and that there is a minimum clearance of 150mm (6") from the blade tip to the wall or ceiling. Please note that the bigger this clearance is the better the airflow from your fan will be. Ensure the blades are mounted at a minimum height of 2.3 meters (7'6") from the floor when the fan is installed.
4. The fixing point for the fan must be able to support a weight of ten times that of the net weight of the fan. Net weights can be found on the bottom of the unit's box. If you are mounting the fan to a ceiling junction box, the box and it's fixing must be able to support the moving weight of the fan and must not twist or work loose.
5. The fan must be earthed.
6. Do not connect the fan motor to a dimmer switch. This may give an unsatisfactory performance (motor hum) and cause damage to the motor.
7. It is not recommended that ceiling fans and gas appliances are operated in the same room at the same time.
8. The fan must be turned off and stopped completely before reversing the fan direction. This will prevent any damage to the motor of the unit or controller (if installed).
9. Do not insert anything into the fan blades while the fan is operating. This will damage the blades and upset the balance of the unit causing the unit to wobble.
10. After the fan is completely installed make sure that all connections are secure and tight to prevent any problems.
11. Because of the fan's natural movement, some connections may loosen. Check the support connections, brackets and blade attachments twice a year to make sure they are all secure. If they are loose tighten with a screwdriver. ( It is not necessary to take the fan down from the ceiling )

**Note :** The important safeguards and instructions given in this manual are not meant to cover all possible conditions and situations that may occur. It must be understood that common sense, caution and care are factors which cannot be built into any product. These factors must be supplied by the persons caring for and using the unit.

For installation advice, or in the unlikely event of damaged or missing parts please ring:

**HELPLINE : 01959 564440**

## Supplied Parts

- One fan motor assembly
- One hanger bracket fitted with terminal block and top rubber washers.
- One 4" drop rod & top & bottom canopy
- One set of blades carrier
- One set of blade
- One screw-pack with balancing kit
- One installation booklet.
- Remote control set

## Tools and Materials Required

- Philips screwdriver
- Blade screwdriver
- Small electrical screwdriver
- Electrical pliers
- Step ladder
- Wiring supplies as required by current electrical practice
- Bulbs if a light fitting is fitted / to be fitted
- In-line crimps or other suitable connectors if an extension rod in excess of 760mm (30 inch) is to be fitted.

Before starting the assembly and installation of your fan please ensure the safety precautions have been read and understood.

## Installation Difficulties, Missing or Damaged Parts

If you have any difficulty in installing your fan/light or if you are unfortunate enough to find that your fan has been dispatched with parts missing or damaged please contact our help-line on (01959 564440). We will be very pleased to provide help or forward replacements parts to you immediately.

In any communication with us please quote model reference, colour of the unit and the part missing or damaged.

**HELPLINE**  
**01959 564440**

## Parts names and their relative positions

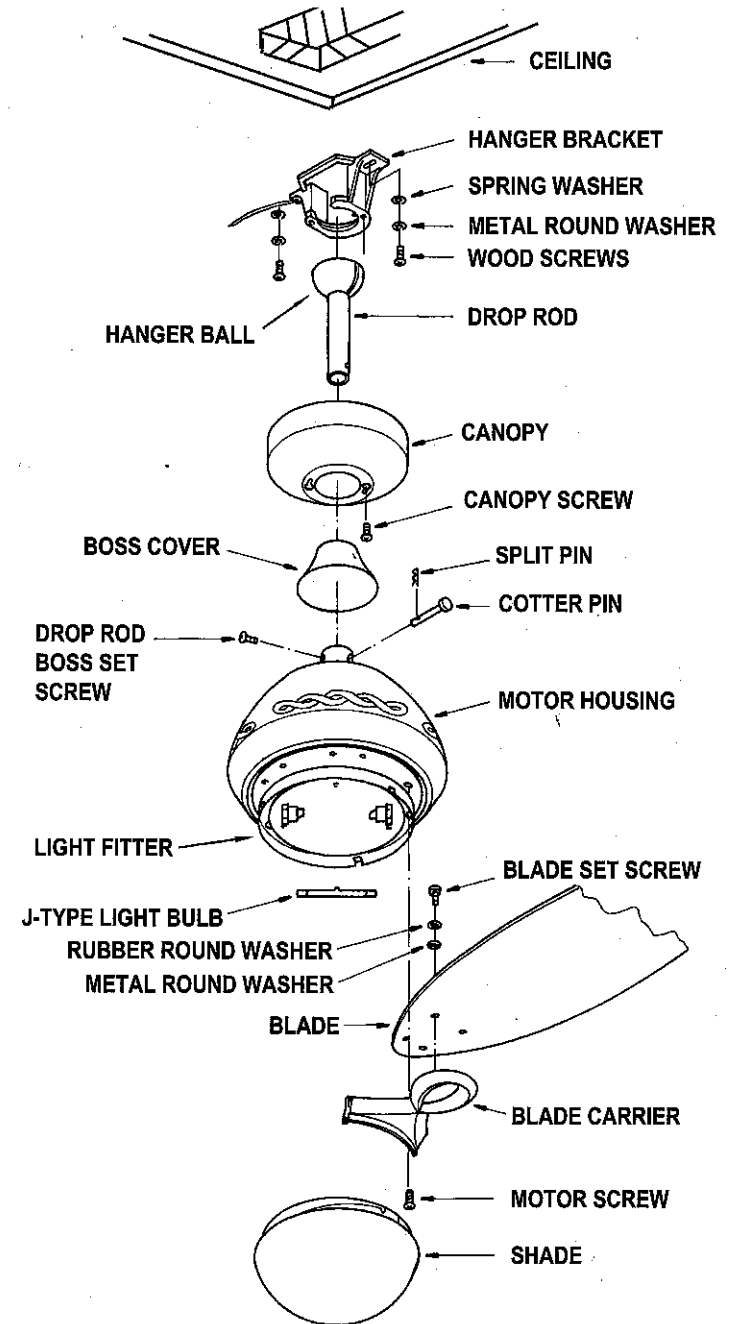

## Installing the fan

All electrical work should only be undertaken after disconnection of the power by removing fuses or turning off the circuit breaker to ensure all pole isolation of the electrical supply.

Your fan is a drop rod fan (Picture A) In this situation the drop rod assembly is used to lower the fan down from it's mounting position slightly. Extension rods, ranging from 12" to 48", are available if you need to lower your fan further. (This is normally the case in conservatories or rooms with very high ceilings.)

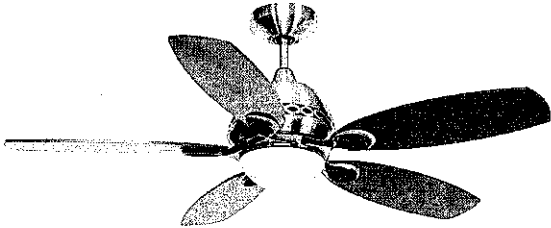

Picture A

The following steps will guide you to a successful installation:

1. Hanger bracket installation
2. Drop rod assembly
3. Remote control and Wiring instruction
4. Attaching the blades
5. Installing light bulb and glass

### 1. Hanger bracket installation

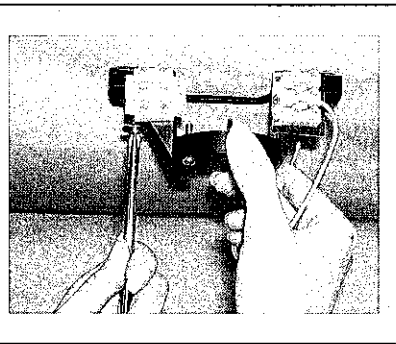

The hanger bracket should be screwed on to a firm flat surface. The fixing location must be able to withstand ten times the static weight of the fan. If you have any doubts as to the ability of your intended fixing location to be able to withstand this loading. Please contact our service help-line or another competent authority to advise you. In most situation two wood screws screwed into a wooden joist is more than adequate to support your ceiling fan.

The hanger bracket should be screwed onto the joist with the two wood screws provided. The washers provided should go in the following sequence:

Screw head > round washer > spring washer > Hanger bracket > Ceiling. Screw the hanger bracket to the ceiling and make sure all connections are secured to prevent the fan from falling. Fixings must screw into a joist and not just the plasterboard. Loosen the two canopy screws from the hanger bracket.

### 2. Drop rod assembly

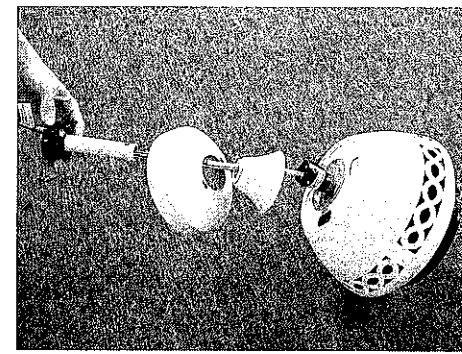

Remove the cotter pin and clevis pin from the bottom of the drop rod. If a longer drop rod is going to be used transfer the ball joint and the earth wire to the longer rod. Put the drop rod through the flared end of the top bottom and fix ring and boss cover and bottom canopy and pass the electrical supply leads from the top of the motor through the drop rod until they exit at the top of the ball joint. Always ensure the rod passes through the canopy and boss cover before the rod is connected to the fan. If an extension rod longer than 30 inches is to be used, the cables will need to be extended in an appropriate way.

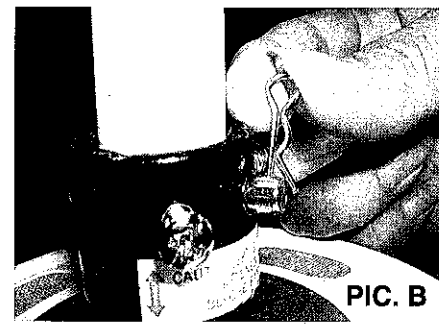
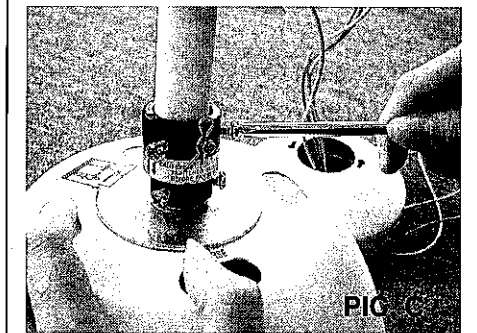
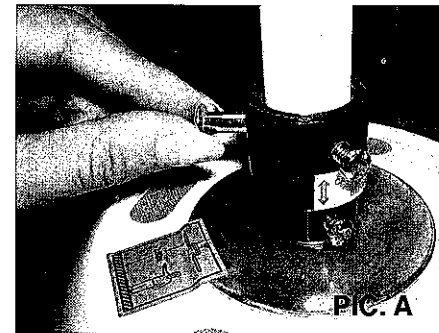

Loosen the drop rod set screws on the boss, which is on top of the motor and insert the drop rod into the drop rod boss on top of the motor casing. Turn gently to align the holes in the boss with those in the rod. Ease the cotter pin through the boss and the rod (PIC.A) taking care not to pinch or damage any cables. Fix in place by replacing the split pin (PIC.B) Tighten all set screws at this point. This prevents the rod and the fan moving in relation to one and other. It also assists in maintaining a good earth continuity through the fan, which is important to the safety of the unit.



Once the drop rod assembly has been fitted-

Lift the fan up to the hanger bracket, Steer the ball in from the side of the bracket and lower it into the recess of the bracket.

Rotate the ball around until the groove in the side of the ball aligns with the protrusion on the upper edge of the recess. When aligned the fan should drop slightly as it assumes it's correct position. This is to prevent rotation of the rod and fan when the unit is working.

Connect the wiring as shown following step

### 3. Remote control and Wiring instructions

**WIRING INSTRUCTIONS :** *Before doing wiring, ensure that you have all pole disconnection of the electricity supply.*

Your fan is supplied with a radio frequency remote control unit, and the fan does not have a pull switch for speed control, the fan can only be controlled by remote control. You can find the unit in the box. Before connecting the wiring, please set up the code of remote control.

**CODE SWITCH:** Codes are set by pushing dip switches up or down. It is imperative that the code used for both transmitter and receiver is exactly the same, otherwise the remote control will not work. Please note the code switch will enable you to operate a second remote controller independently. For example, if you have two ceiling fans with 2 remote control units, set 2 different codes for each set of transmitter/receivers. This means you can operate each ceiling fan independently. Please see following drawing.

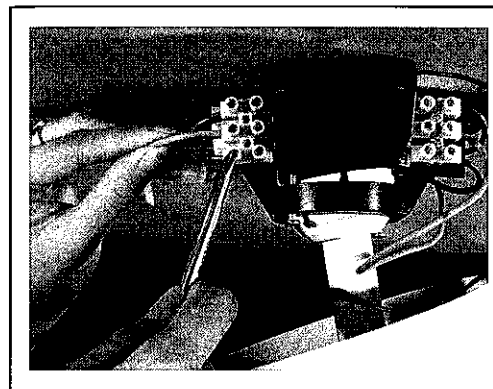
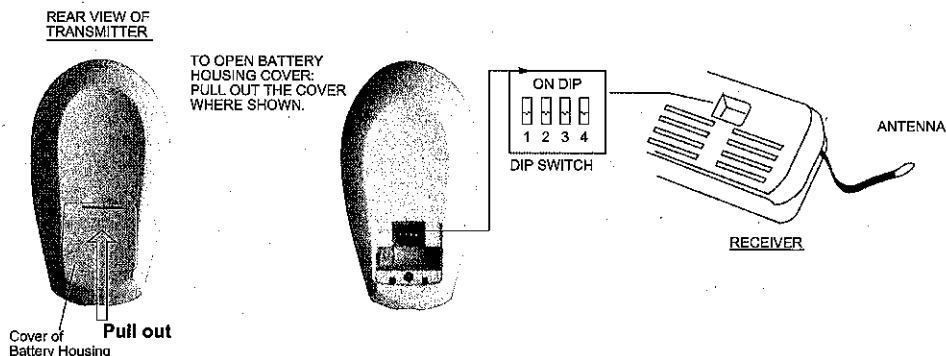

Put the receiver of remote control through hanger bracket (as picture).

Connect the A.C. power supply wire that come from the ceiling to the Brown and blue wire of receiver which is mark with label "L" & "N". In most cases, RED wire is LIVE is connected to "L" BROWN wire , BLACK wire is NEUTRAL is connected to "N" BLUE wire.

Connect the 4 lead wires coming from the fan housing with 4 wires coming from the other side of the remote control receiver where indicated sticker with brown, blue, orange block.

BRN TO BROWN (Live wire of fan) BLUE TO BLUE (Neutral wire of fan)  
ORG TO ORANGE (Live wire of light) GRN/YEL TO GRN/YEL (Earth wire)

**IMPORTANT : THIS APPLIANCE MUST BE EARTHED.**

### 4. Attach the assembled blades

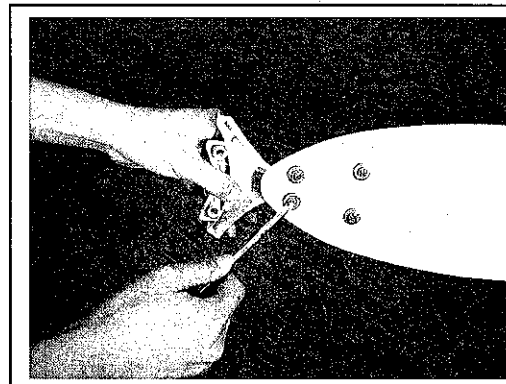

The blades now need to be assembled on to the carrier brackets.

Carefully unwrap the blade and a carrier bracket. Align the bracket with the holes in the blades and use the screws and fibre washers provided to connect them.

The rubber round washer and metal round washer should go on top the blade between the head of the screw and the surface of the blade. Ensure the screws are tightened up firmly.

Repeat this process for all blades.



There are two gaps on the light fitter plate for putting screws to screw the blade carrier onto motor. Putting the carrier bracket on the surface of motor. Using the motor screw and the spring washers provided, bolt the blade carrier bracket onto the motor. Ensure the bolts are tightened firmly.

Be careful not to bend the blades or the carrier brackets during installation as this may result in an imbalance and induce wobble.

If installing more than one fan be careful not to mix the blade sets. Each set is carefully manufactured to be evenly balanced, mixing would break up a balanced set and again this could induce wobble.

#### 5. install bulb and shade



Your fan is supplied with 100W light bulb.

You must not touch new bulb with bare fingers when you take the bulb from box. The body oil residue may cause the bulb to explode. Use tissue or cloth to protect the new bulb from your fingers.

Before install the bulb, make sure the power is disconnected. Put the J- Type 100W Max. to the socket in the fitter.

*Now is a good time to test that the fan operates correctly. Turn on the power and use the transmitter to Control your fan, checking the fan speeds and light kit are worked properly. Please see page 10 for remote control function details.*

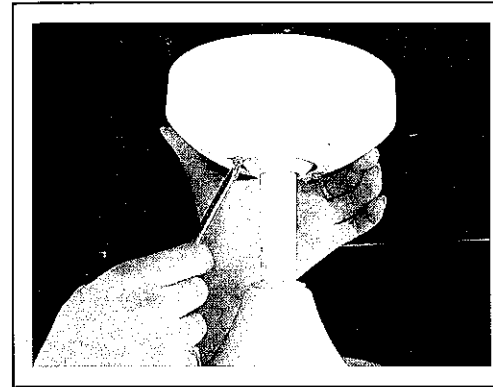

After finishing the following step for installing light bulb and make sure light is worked properly, please lift the canopy and carefully up to hanger bracket, carefully put all wires into the canopy and don't bent or broken the wire. Use the canopy set screw to screw it firmly.

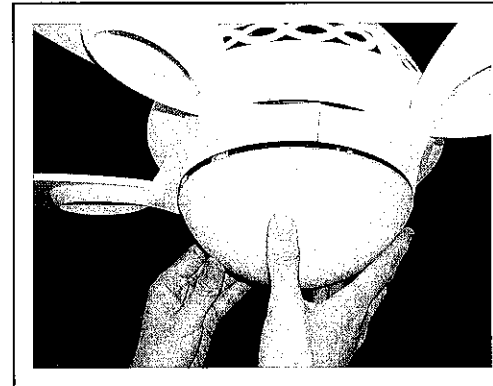

Put the shade into the light fitter and twist it tight. Ensure the shade is tighten firmly, the shade will drop off and broken not installed properly .

Now, your fan installation is complete.

# HOW TO OPERATE THE HANDSET (TRANSMITTER)

The wireless remote control is designed to control all commonly used features except the airflow upward and downward reversing function. The reverse switch is on the fan housing (a slide switch). Please change the airflow direction manually.

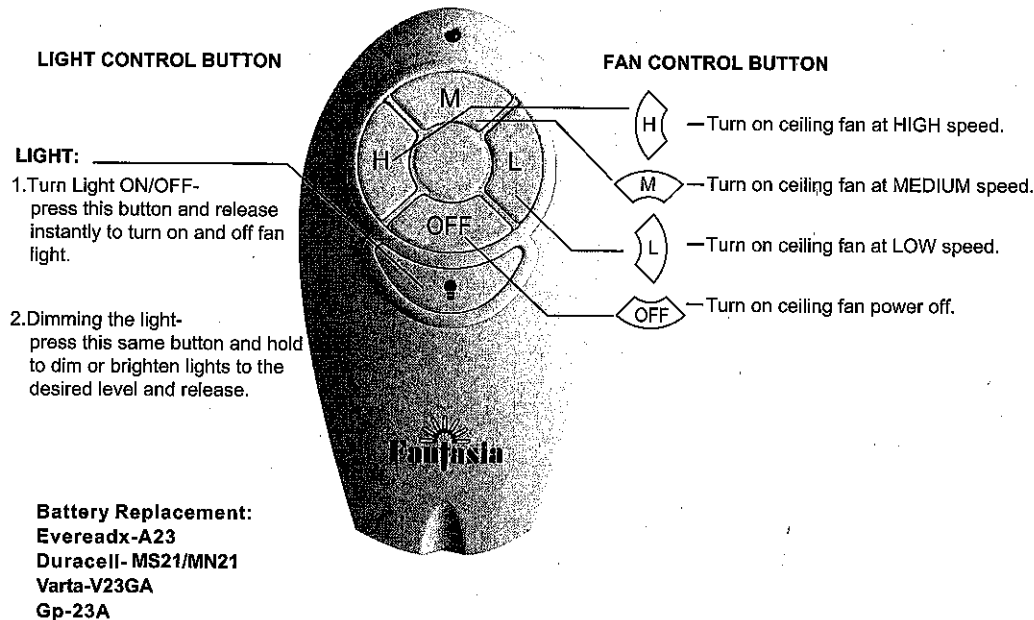

## NOTE:

1. Please allow a moment between each operation.
2. Please handle the transmitter with care, be sure not to drop or expose it to water, high humidity or place where is too close to a heating element. Improper handling may result in malfunction and void the warranty.
3. The remote control is operated by Radio Frequency, so, it won't be necessary to point this unit at the ceiling fan while activating the handset functional button.

## Operating instructions

Having checked that all electrical connections are securely made and insulated, turn on the power and check the operation of the fan. Use the remote control to change the speed High-Medium-Low and off.

The slide switch on the top of housing changes the direction of rotation of the blades. (Remember to let the fan slow to a complete stop before changing the direction of rotation). When looking up at the fan blades, anti-clockwise rotation achieves a downward flow of air and clockwise rotation achieves an upward movement of air.

**Summer operation** – In warm weather a downward movement of air is more desirable as this achieves a greater cooling effect.

**Winter operation** – In winter a movement of air moving upwards and then back down the sides of the room achieves a more balanced temperature throughout the room.

## Blade balancing

Whilst every precaution is taken at the factory to ensure your fan is of the highest quality, imbalance may occur. This may be due to slight irregularities in the blades or blade carriers. Further problems can be caused by deviating from these instructions.

The following procedure may help to rectify the situation.

The hanger bracket must always be tight against the ceiling so that no movement can occur.

Make sure that the rod is firmly locked into the boss on top of the fan. The locking screw should be securely tightened.

Check all the blades are firmly tightened onto motor.

Blade tracking can easily be checked by holding a yardstick or similar measure vertically from the ceiling to the tip of the blade. Then check all blades measure the same distance from that point. To correct slight problems in the alignment of a blade, gently bend the carrier to bring it back in line.

Changing over two adjacent blades – may correct any imbalance.

Use the universal balancing kit supplied with the fan.

Please note that drop rod styles of fans do have a slight level of movement but this is in no way dangerous.

## Care and cleaning

Ensure that periodic checks of the fixings takes place. (see Safety Precaution 9)

Periodic cleaning of your new Fantasia fan is recommended particularly the blades. The plated or painted surfaces of your fan have been sealed with a lacquer to minimize any discoloration or tarnishing. Therefore use a soft brush or lint free cloth to avoid scratching the surface.

The motor has permanently sealed bearings so no lubrication is necessary

Do not use water when cleaning you fan as this could damage the surfaces of the casing and the blades and may create the possibility of a electric shock.

## Tips from Fantasia

If you have a false ceiling, connect the hanger bracket on to the main structure and use an extension rod to lower the fan below the false ceiling. (Remember to allow adequate clearance for the rotating blades.)

The hanger bracket can be mounted on to a surface up to 40°. The fan will have to be installed in the drop rod style of mounting for this (Remember to allow adequate clearance for the rotating blades – see Safety Precaution 3).

If you are installing more than one fan make sure that you do not mix the fan blade sets.

## Fault Finding

Noise level unacceptable	Noises from fans are usually due to something Being lose on the fan. As a first corrective measure ensure all screws are tight.
Fan wobbles excessively	The blades may have imbalance. Follow the blades Balancing section. The drop rod boss set screws may not be locked tightly. Tighten and retry.
Fan will not rotate	Check supply connections. Check that the blades are not fowling anything
Fan is tarnishing	Check that no solvents have been used in the vicinity of the fan – especially floor adhesives and brick acids.

## Product Disposal Instructions

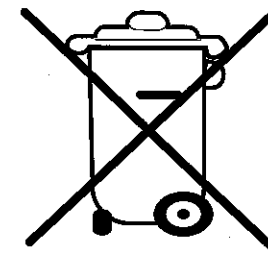

This product has been classed as Electrical or Electronic Equipment and should not be disposed of with other household or commercial waste at the end of it's working life.

The Waste of Electrical and Electronic Equipment (WEEE) Directive (2002/96/EC) has been put in place to recycle products using best available practice and minimise the impact upon the environment.



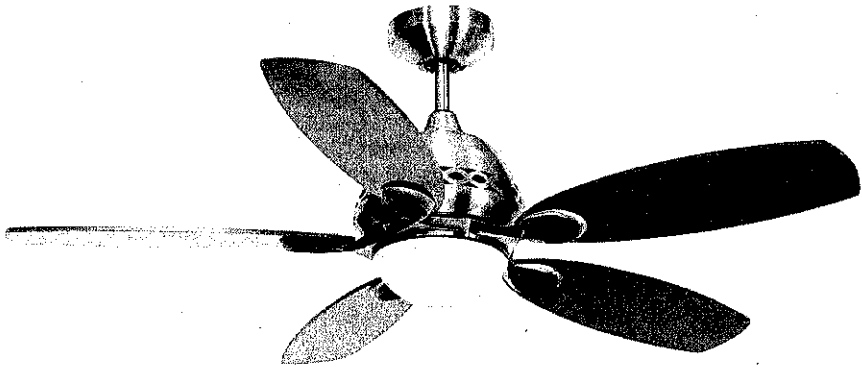

106cm/42"

# Phoenix

**FANTASIA DISTRIBUTION LTD.**

**Unit B. The Flyers Way, Westerham, Kent, TN16 1DE**

**Tel : (01959) 564 440 Fax : (01959) 564 829**

**E-MAIL: [info@fantasiaceilingfans.com](mailto:info@fantasiaceilingfans.com)**

CSA7041801