

For technical and support queries please contact :
Fantasia Distribution Ltd on 01959 564440

ASSEMBLY AND INSTALLATION MANUAL OF CEILING FAN

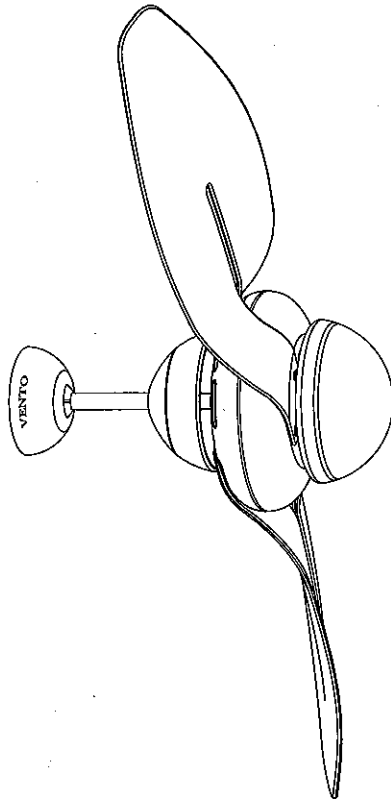

DRAGONFLY (LIBELLULA)

I. IMPORTANT SAFETY INSTRUCTIONS

1. Installation must be carried out by a qualified electrician.
2. Turn off the electrical mains at the circuit breaker/fuse box.
3. Do not use power supply other than 230V / 50Hz.
4. This appliance must be earthed.
5. When mounting the fan, ensure that the safety wire is looped across the mounting bracket.
6. The mounting bracket must be able to withstand a min. weight of 35 pounds.
7. The ceiling fan must be mounted at a min. height of 7.5 feet / 2.3m of clearance from the floor.
8. Do not place any objects in the path of the blades.
9. When all electrical connections are done, store all wires neatly.
10. Make sure that all screws and connections are tightly screwed and secured.

Warning

This product is designed to use only those parts supplied with this product and/or accessories designated specifically for using with this product. Using parts and/or accessories not designated for using with this product could result in personal injury or property damage.

Note

This illustrations in this manual are for explanation purposes only and may differ from the actual unit. It is subjected to change without prior notice for further improvements.

II. FOR YOUR CONVENIENCE ON ASSEMBLY & INSTALLATION, PLEASE FOLLOW THIS MANUAL DESCRIPTION

1. Tools:

- A. Philips Screwdriver
- B. Slotted Screwdriver
- C. Adjustable wrench
- D. Cutter
- E. Ladder

F. Install the power cord in accordance with the cord

2. Check if all parts and accessories are present:

- | | | |
|---------------------|--|---|
| A. Mounting Bracket | I. Remote Control | J. Screw Pack |
| B. Downrod Set | a. Transmitter | h. Expansion Screws For Mounting Bracket x2 |
| C. Canopy | b. Transmitter Cover | i. Screws For Mounting Bracket x2 |
| D. Decorative Cover | c. Receiver | j. Clasp x1 |
| E. Upper Housing | d. Wall bracket For Transmitter | k. Screws For Upper Housing x6 |
| F. Fan Body | e. Battery | l. Blade Screws x9 |
| G. Blades x2 | f. Instruction Manual For Remote Control | m. Blade Washers x9 |
| H. Glass Shade | g. Accessories Packet | n. Wire Connector x3 |
| | | o. Balance Pack x1 |

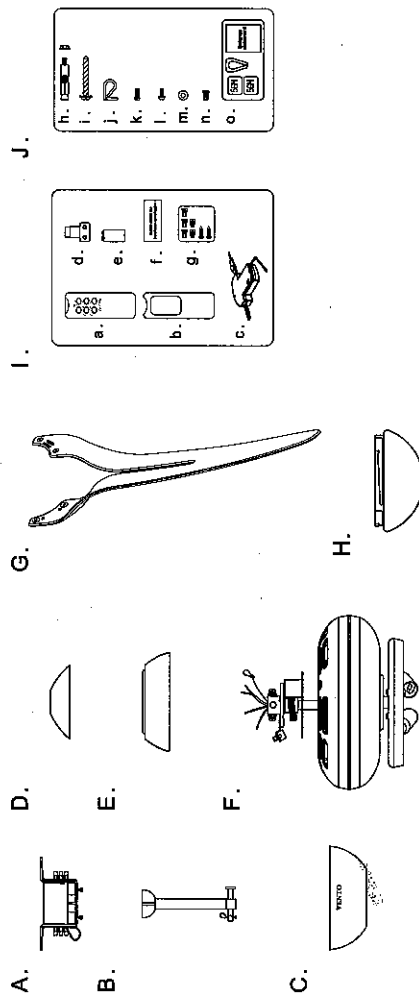

NOTE: THE TRANSMITTER IS DESIGNED FOR USE WITH EITHER WALL BRACKET FOR TRANSMITTER (d.) OR THE TRANSMITTER COVER (b.)

NOTE: PLACE THE PARTS FROM (J.) SHOWN ABOVE, IN A SMALL CONTAINER TO PREVENT PARTS FROM GETTING LOST. IF ANY PARTS ARE MISSING, CONTACT YOUR LOCAL RETAILER FOR REPLACEMENT BEFORE PROCEEDING.

III. INSTALLATION INSTRUCTION

ATTENTION: Do not install the fan onto the partition ceiling or chapped wall.

1. The ceiling fan must be mounted at a min. height of 7.5ft/2.3m of clearance from the floor.

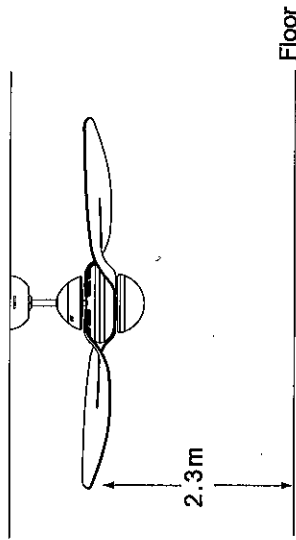

2. The mounting bracket must be securely fastened to a structural ceiling member.
- NOTE:** a.) Please choose one of the following ways to install the mounting bracket.
b.) Make sure all screws are tightened.

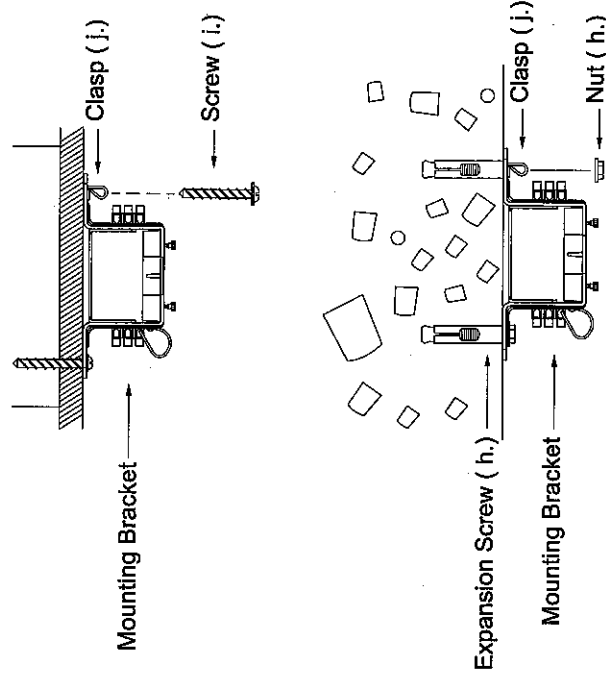

3. Align holes on blades to the holes on fan body then tighten screws on top and bottom of the blade. Please make sure that the marking "THIS SIDE UP" is facing the ceiling when installing.

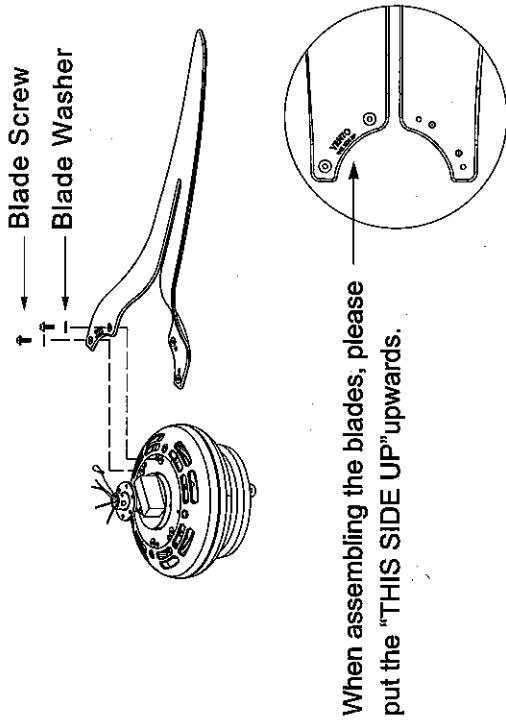

4. Install the upper housing by threading the power leads and fix six screws.

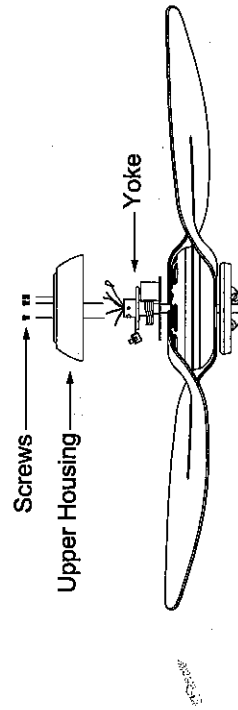

5. Loosen 2 screws at the yoke of the motor assembly. Slide the canopy into the downrod. Thread the power leads from the fan through the canopy, decorative cover and downrod (take extra care not to pull power wires damage). Set downrod into yoke and rotate until the holes match. Then, insert lock pin through the holes and firm it with R pin. Tighten 2 screws and nuts at the top yoke of the motor assembly.

ATTENTION: Make sure the R pin and lock pin is proper and secure to prevent the fan from falling or causing property damages or personal injury.

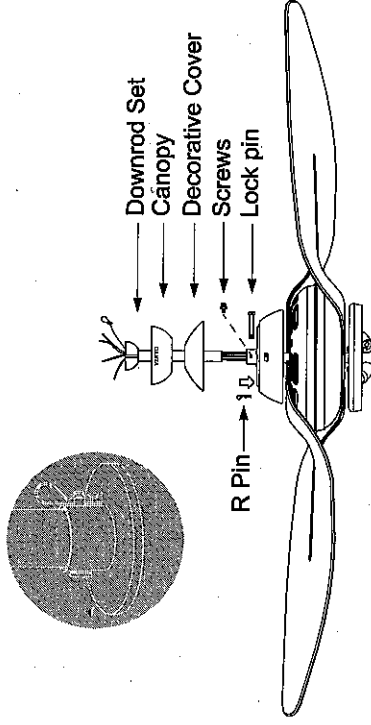

6. a.) When mounting the fan, ensure that the safety wire is looped across the mounting bracket.
b.) Tighten the two downrod set screws to make sure the fan run stably. Then, install downrod (ball part) into mounting bracket opening that already securely fastened to a structural ceiling member. The tab opposite of the mounting bracket opening should fit in slot on ball.

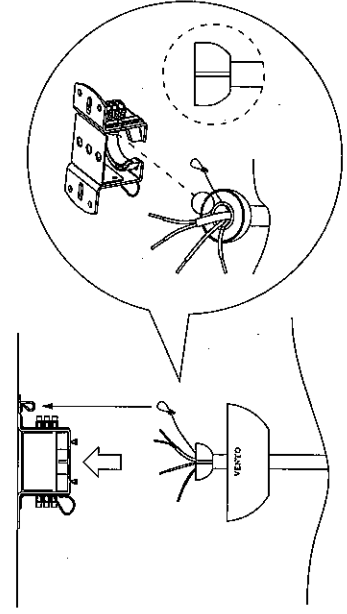

7. Insert the receiver into the mounting bracket (see the illustration on page 9-11). Loosen the screws from the mounting bracket, uphold the canopy to cover the mounting bracket, then let the mounted hole aim at the screws, then firm the screws.

ATTENTION: Make sure all wires are proper connected.

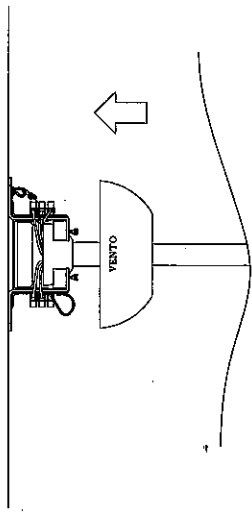

8. Place the blade bottom onto the screw hole. Put the washer and fix the screw. Then, install light bulb (not included) into the light kit. Next, fix the glass shade. (Bulb specification according to actual type of light kit)

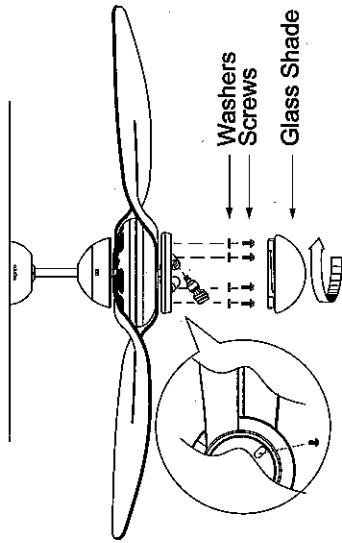

9. Reversible switch: switch to the left is downward airflow and switch to the right is upward airflow. (The illustration for user reference only, the actual airflow depends on on-site situation.)

NOTE: Set the reversible switch when the fan stops completely.

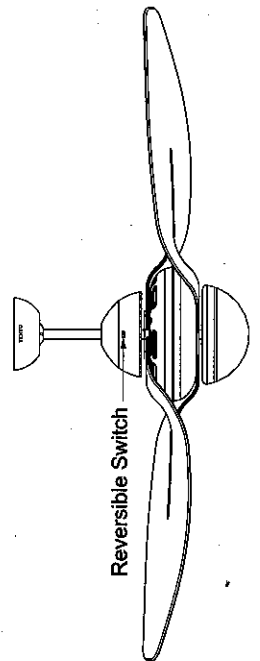

SUMMER MODE: The reversible switch is in the "left" position to make the airflow will be directed downwards for cooling in summer.

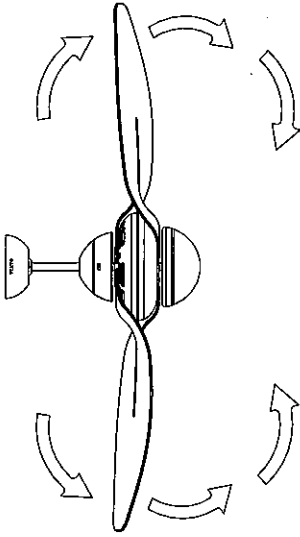

SUMMER MODE

WINTER MODE: The reversible switch is in the "right" position to make the airflow will be directed upwards for energy conservation in winter.

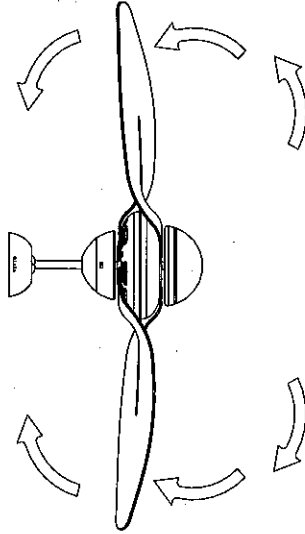

WINTER MODE

IV. INSTALLATION INSTRUCTIONS FOR CEILING FAN REMOTE CONTROL

A. IMPORTANT POINTS:

1. Please read this manual and keep it for future use.
2. Turn off the electrical mains at the circuit breaker/fuse box.
3. Please note that all wiring connections should be done by a qualified electrician.
4. This unit is to be used in an AC230V / 50Hz supply zone only.
5. Do not install in damp locations or immerse in water. (For indoor use only.)
6. To avoid damaging the transmitter prevents dropping or banging the transmitter.
7. Do not attempt to shorten the receiver's antenna wire.
8. If the transmitter is not used for some time, please remove batteries to avoid leakage that will damage the transmitter.

B. OPERATION INSTRUCTIONS:

1. After installing the receiver, make sure the transmitter has its batteries installed.
2. If the transmitter is not functioning properly or not function or if the fan is not moving please do the followings:
 - a) Turn off the electrical mains at the circuit breaker/fuse box.
 - b) Follow steps on page 9-10 to reinstall the receiver.

C. FUNCTIONS OF TRANSMITTER:

- HI** : Set fan to high speed.
MED : Set fan to medium speed.
LOW : Set fan to low speed.
OFF : Turn off the ceiling fan.
LIGHT ON : Turn on the light.
LIGHT OFF : Turn off the light.

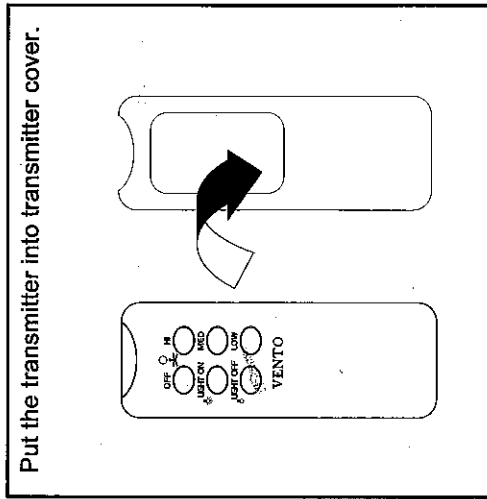

Put the transmitter into transmitter cover.

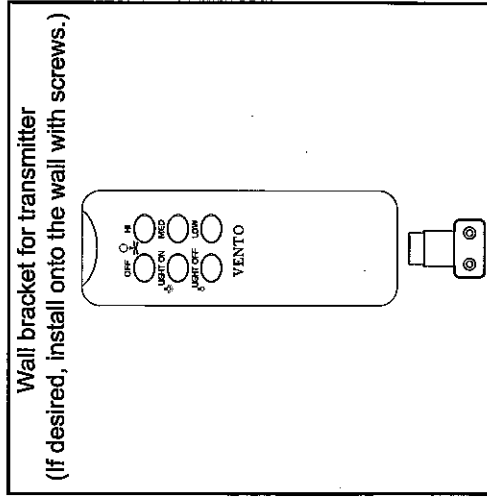

Wall bracket for transmitter
(If desired, install onto the wall with screws.)

V. CODE SWITCH SETTING

1. These DIP code can be pushed upward and downward to change the setting.
2. Both of these remote control components (receiver and transmitter) have a set of four switches that need to have the same settings. (The total combination becomes 16 frequency codes).
3. The setting determines the frequency that will be used to control the ceiling fan. Otherwise, the ceiling fan will not operate.
4. Once the setting has been made, slide down the back cover of transmitter to the arrow direction. Install a 9 Volt battery.
5. Now the remote control receiver module is ready for installation up at the ceiling fan of mounting bracket.
6. Select different combinations of dip switches to prevent mis-operation due to other remote control fans.

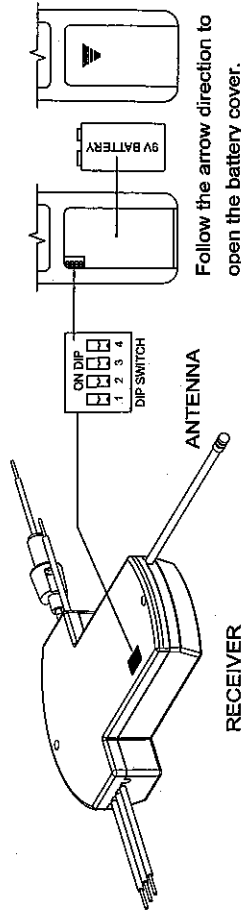

RECEIVER

NOTE: THE TRANSMITTER IS DESIGNED FOR USE WITH EITHER WALL BRACKET FOR TRANSMITTER (c.) OR THE TRANSMITTER COVER (b.)

VI. WIRING FOR CEILING FAN INSTALLATION

NOTE: a.) Incorrect wire connection may damage this fan and receiver.
 b.) Do not attempt to shorten the receiver's antenna wire.

1. A typical ceiling fan remote control is wired as shown in this wiring diagram. (Fig. 1)
 Make sure that the wire of brown/blue/orange is connected.
2. Wires connecting the receiver and the ceiling fan have its sticker indication. The receiver wires to the fan motor are Blue (neutral) marked TO MOTOR N and Brown (live) marked TO MOTOR L. Orange is for the light fixture marked FOR LIGHT. Connect wires with sticker indicating "AC IN" from the receiver-Red (live) and White (neutral) to the wires from the ceiling.
3. Make sure that the ground wire from the ceiling is connected to the GREEN/YELLOW wire of the ceiling fan.
4. After connecting the wires, push up the canopy till it reaches the ceiling then install the receiver by sliding into opening in the mounting bracket. Tighten the canopy screw. As shown in Fig.2

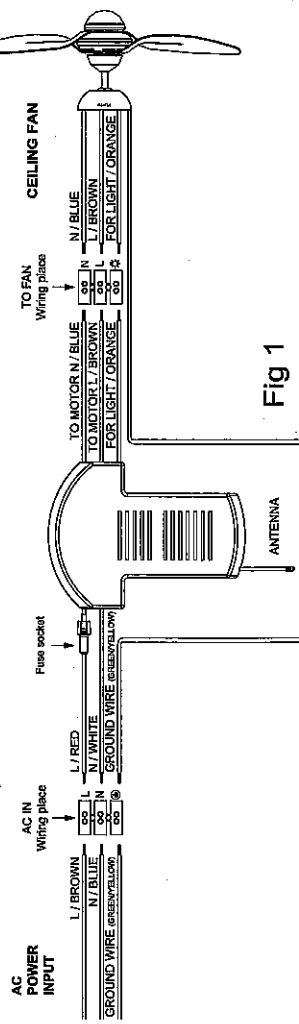
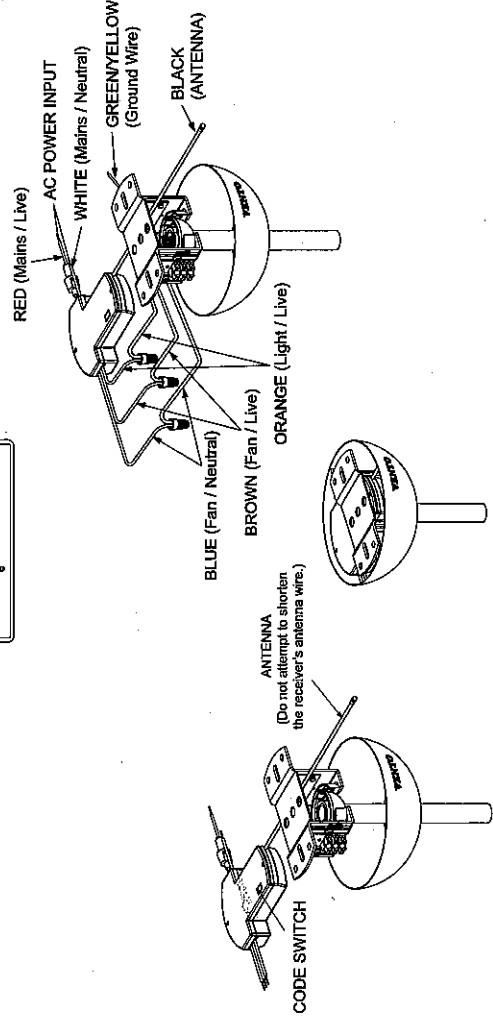

Fig 1



COMPLETE DIAGRAM

Fig 2

VII. FUSE REPLACEMENT

Push both side of the fuse capsule towards each other and twist it to open the fuse capsule. Remove the damaged 5A glass fuse from the capsule then replace a new 5A glass fuse. To close the fuse capsule align the latch and groove then push in and twist to lock the fuse capsule.

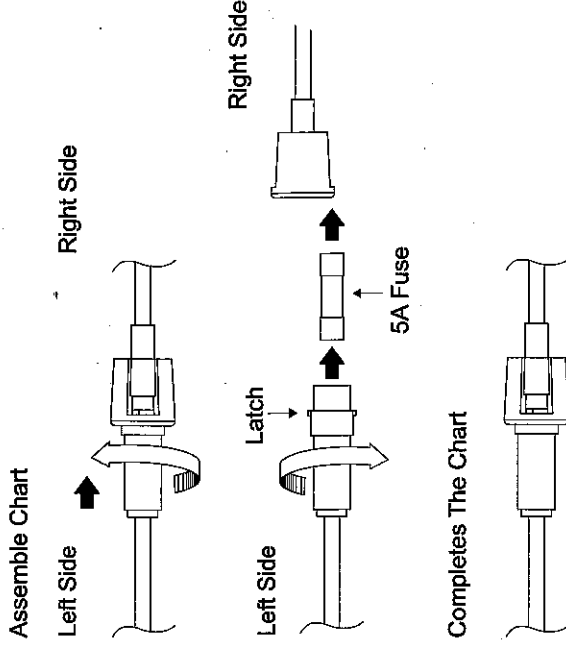

VIII. TROUBLE SHOOTING

PROBLEM A: FAN WILL NOT START REMEDIES:

1. Check fuse or circuit breaker and replace if necessary.
2. Check that reversible switch is at exact position.
3. Turn off electrical power, check all wire connections.
4. Check to make sure the dip switches from the transmitter and receiver are set on the same frequency.

PROBLEM B: FAN EXCESSIVELY NOISY REMEDIES:

1. Check that all screws in fan assembly are tight and properly seated.
2. Check to make sure mounting bracket is installed properly.
3. Check to make sure light kit and glass are tight and installed properly.

PROBLEM C: FAN WOBBLER REMEDIES:

1. Check that all blades are screwed firmly into blade brackets.
2. If the above mentioned remedies can't eliminate the wobble, use the clip from balance pack to make sure the position. Stick the balancing weight on the opposite side of the mark place.